

Circuit Diagram

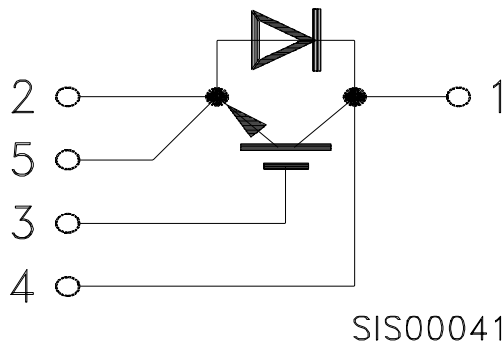

Package Outlines

Dimensions in mm

Weight: 420 g

