

European Power-Semiconductor and Electronics Company GmbH + Co. KG

Leistungsgleichrichterdioden Power Rectifier Diodes D 798 N

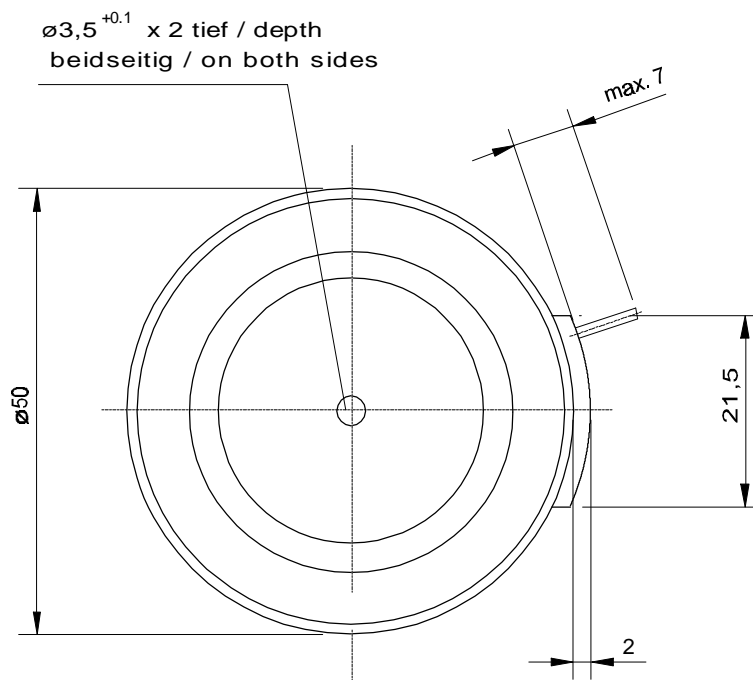
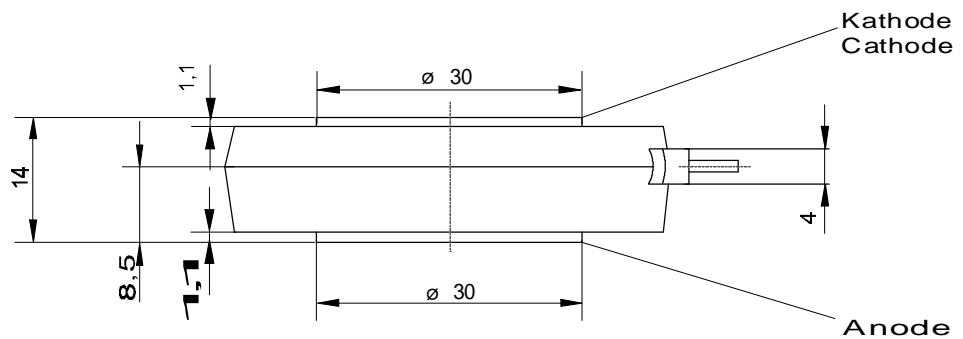

D 798 N

Elektrische Eigenschaften

Electrical properties

Höchstzulässige Werte

Maximum rated values

Periodische Spitzensperrspannung	repetitive peak reverse voltage	$t_{vj} = -40^{\circ}\text{C} \dots t_{vj \max}$	V_{RRM}	800, 1200 1400, 1800	V V
Stoßspitzensperrspannung	non-repetitive peak reverse voltage	$t_{vj} = +25^{\circ}\text{C} \dots t_{vj \max}$	$V_{RSM} = V_{RRM}$	+ 100	V
Durchlaßstrom-Grenzeffektivwert	RMS forward current		I_{FRMSM}	1650	A
Dauergrenzstrom	mean forward current	$t_c = 130^{\circ}\text{C}$ $t_c = 106^{\circ}\text{C}$	I_{FAVM}	800 1050	A A
Stoßstrom-Grenzwert	surge forward current	$t_{vj} = 25^{\circ}\text{C}, t_p = 10 \text{ ms}$ $t_{vj} = t_{vj \max}, t_p = 10 \text{ ms}$	I_{FSM}	14,8 11,8	kA kA
Grenzlastintegral	$I^2 t$ -value	$t_{vj} = 25^{\circ}\text{C}, t_p = 10 \text{ ms}$ $t_{vj} = t_{vj \max}, t_p = 10 \text{ ms}$	$I^2 t$	1095 696	kA^2s kA^2s

Charakteristische Werte

Characteristic values

Durchlaßspannung	on-state voltage	$t_{vj} = t_{vj \max}, i_F = 3,2 \text{ kA}$	V_T	max.	1,77	V
Schleusenspannung	threshold voltage	$t_{vj} = t_{vj \max}$	$V_{T(TO)}$		0,81	V
Ersatzwiderstand	slope resistance	$t_{vj} = t_{vj \max}$	r_T		0,28	$\text{m}\Omega$
Sperrstrom	reverse current	$t_{vj} = t_{vj \max}, V_R = V_{RRM}$	i_R	max.	50	mA

Thermische Eigenschaften

Thermal properties

Innerer Widerstand	thermal resistance, junction to case	beidseitig/two-sided, $\Theta = 180^{\circ} \text{ sin}$	R_{thJC}	max.	0,0460	$^{\circ}\text{C}/\text{W}$
		beidseitig/two sided, DC		max.	0,0415	$^{\circ}\text{C}/\text{W}$
		Anode/anode, $\Theta = 180^{\circ} \text{ sin}$		max.	0,0755	$^{\circ}\text{C}/\text{W}$
		Anode/anode, DC		max.	0,0710	$^{\circ}\text{C}/\text{W}$
		Kathode/cathode, $\Theta = 180^{\circ} \text{ sin}$		max.	0,1045	$^{\circ}\text{C}/\text{W}$
Übergangs-Wärmewiderstand	thermal resistance, case to heatsink	beidseitig /two-sided	R_{thCK}	max.	0,0075	$^{\circ}\text{C}/\text{W}$
		einseitig /single-sided		max.	0,0150	$^{\circ}\text{C}/\text{W}$
Höchstzul.Sperrschichttemperatur	max. junction temperature		$t_{vj \max}$		180	$^{\circ}\text{C}$
Betriebstemperatur	operating temperature		$t_{c \text{ op}}$		-40...+150	$^{\circ}\text{C}$
Lagertemperatur	storage temperature		t_{stg}		-40...+150	$^{\circ}\text{C}$

Mechanische Eigenschaften

Mechanical properties

Si-Element mit Druckkontakt	Si-pellet with pressure contact	$\varnothing = 30 \text{ mm}$				
Anpreßkraft	clamping force	Gehäuseform/case design T	F		6...15	kN
Gewicht	weight		G	typ.	110	g
Kriechstrecke	creepage distance				25	mm
Feuchteklasse	humidity classification	DIN 40040				C
Schwingfestigkeit	vibration resistance	$f = 50 \text{ Hz}$			50	m/s^2
Maßbild	outline					Seite/page

D 798 N

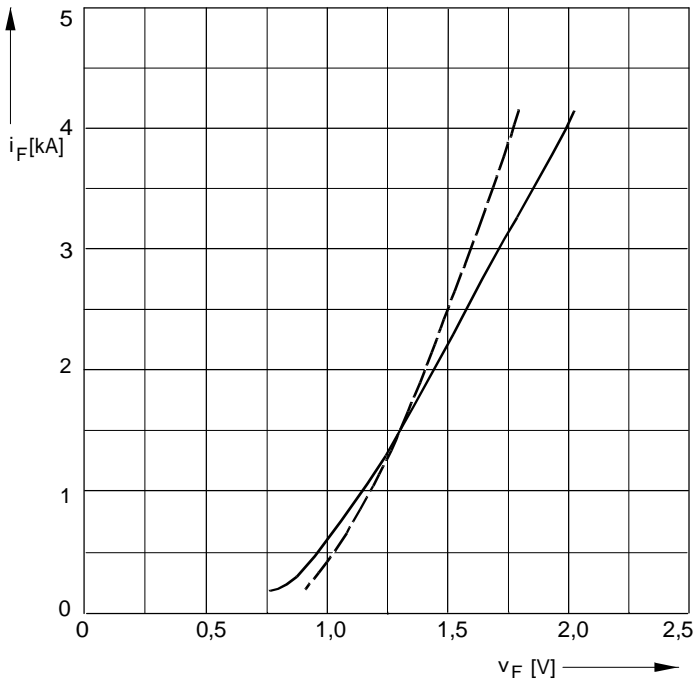

D798N_1

Bild/Fig. 1
Grenzdurchlaßkennlinie
Limiting forward characteristic $i_F = f(v_F)$

- $t_{vj} = 180\text{ °C}$
- - - $t_{vj} = 25\text{ °C}$

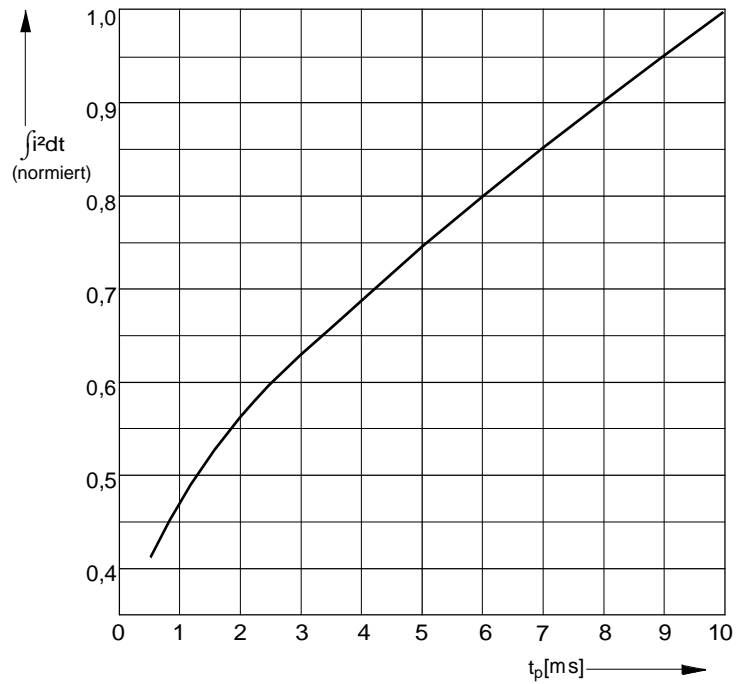

D798N_4

Bild / Fig. 2
Normiertes Grenzlastintegral / Normalized i^2t
 $\int i^2 dt = f(t_p)$

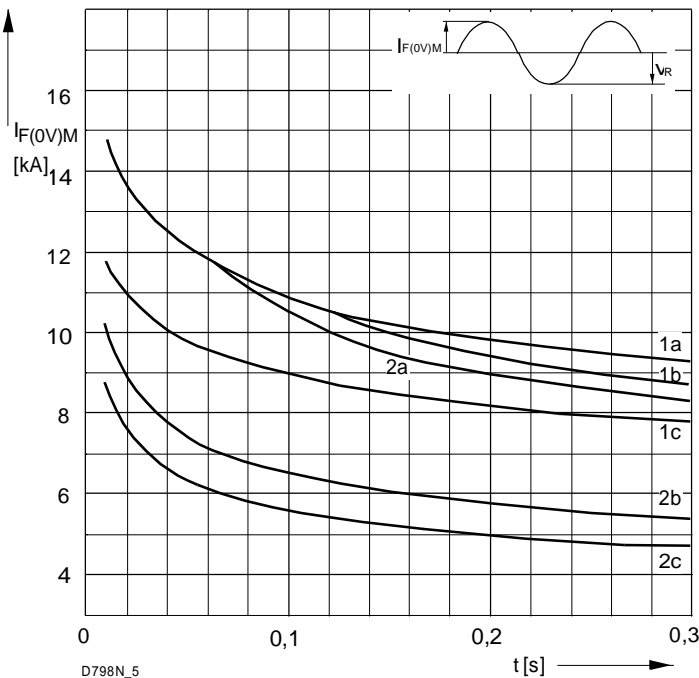

D798N_5

Bild / Fig. 3
Grenzstrom / Maximum overload forward current $I_{F(ov)M} = f(t)$
1 - $I_{FAV(vor)} = 0\text{ A}$; $t_{vj} = t_c = 25\text{ °C}$
2 - $I_{FAV(vor)} = 800\text{ A}$; $t_c = 130\text{ °C}$; $t_{vj} = 180\text{ °C}$
a - $V_R \leq 50\text{ V}$
b - $V_R = 0,5\ V_{RRM}$
c - $V_R = 0,8\ V_{RRM}$

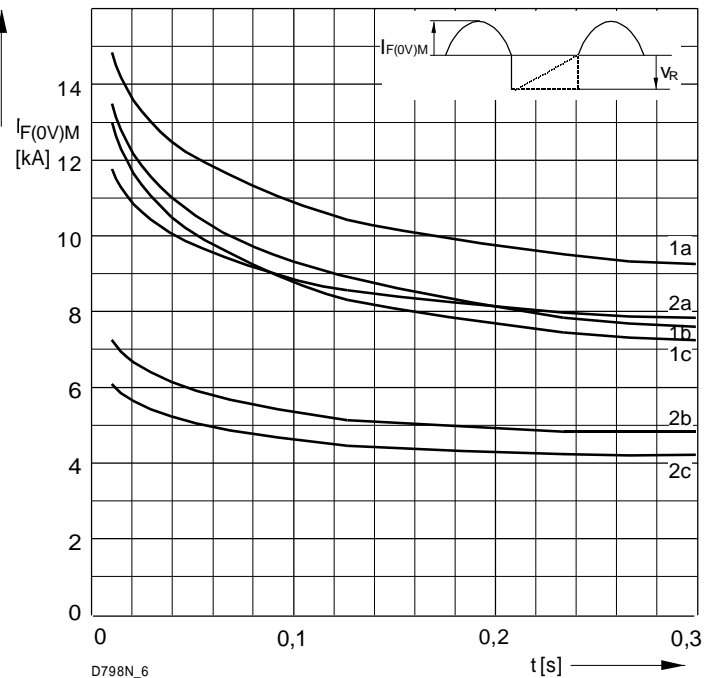

D798N_6

Bild / Fig. 4
Grenzstrom / Maximum overload forward current $I_{F(ov)M} = f(t)$
1 - $I_{FAV(vor)} = 0\text{ A}$; $t_{vj} = t_c = 25\text{ °C}$
2 - $I_{FAV(vor)} = 800\text{ A}$; $t_c = 130\text{ °C}$; $t_{vj} = 180\text{ °C}$
a - $V_R \leq 50\text{ V}$
b - $V_R = 0,5\ V_{RRM}$
c - $V_R = 0,8\ V_{RRM}$

D 798 N

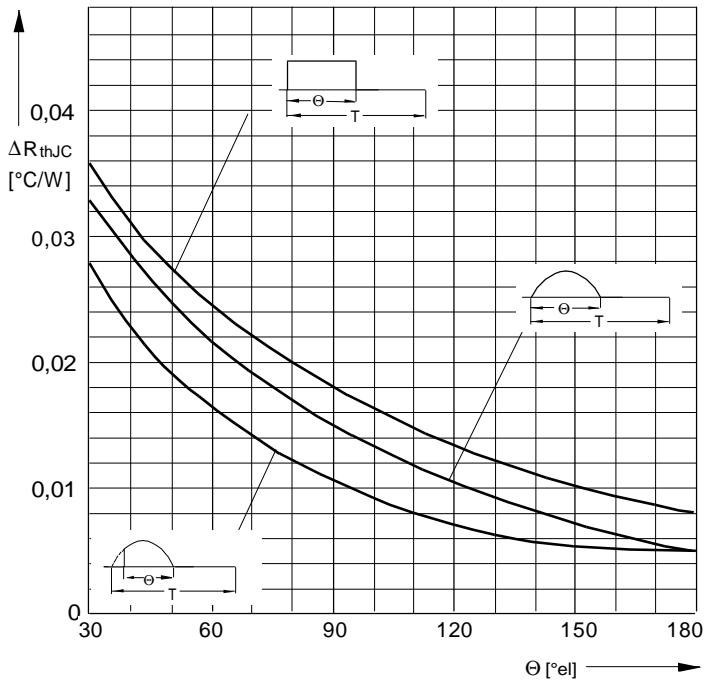

D798N_3

Bild / Fig. 5
 Differenz zwischen den Wärmewiderständen für Pulsstrom und DC
 Difference between the values of thermal resistance for pulse current and DC
 Parameter: Stromkurvenform / Current waveform

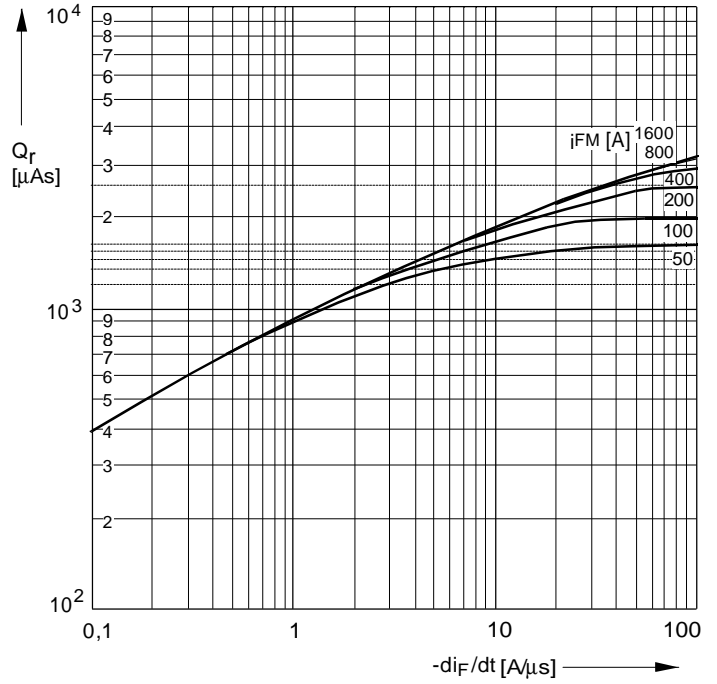

D798N_7

Bild / Fig. 6
 Sperrverzögerungsladung / Recovered charge $Q_r = f(-di_F/dt)$
 $t_{vj} = t_{vjmax}$; $VR \leq 0,5 V_{RRM}$; $V_{RM} = 0,8 V_{RRM}$
 Beschaltung / Snubber: $C = 0,68 \mu F$; $R = 5,6 \Omega$
 Parameter: Durchlaßstrom / Forward current i_{FM}

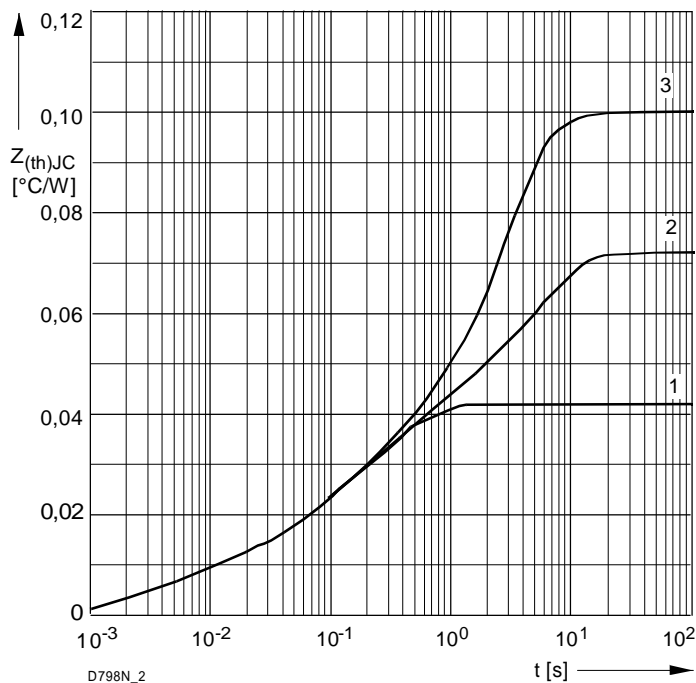

D798N_2

Bild / Fig. 7
 Transienter innerer Wärmewiderstand
 Transient thermal impedance $Z_{thJC} = f(t)$, DC
 1 - Beidseitige Kühlung / Two-sided cooling
 2 - Anodenseitige Kühlung / Anode-sided cooling
 3 - Kathodenseitige Kühlung / Cathode-sided cooling

Analytische Elemente des transienten Wärmewiderstandes Z_{thJC} für DC
 Analytical elements of transient thermal impedance Z_{thJC} for C

Kühlg. Cooling	Pos. n	1	2	3	4	5	6	7
1	$R_{thn} \text{ } ^\circ\text{C/W}$	0,00031	0,00579	0,0114	0,024			
	$\tau_n \text{ [s]}$	0,000136	0,00233	0,0462	0,298			
2	$R_{thn} \text{ } ^\circ\text{C/W}$	0,0006	0,0055	0,0055	0,0223	0,0371		
	$\tau_n \text{ [s]}$	0,000232	0,002548	0,027467	0,152979	3,870018		
3	$R_{thn} \text{ } ^\circ\text{C/W}$	0,000598	0,005532	0,00457	0,0184	0,0709		
	$\tau_n \text{ [s]}$	0,000234	0,00257	0,0278	0,118	2,822		

- 1 - Beidseitige Kühlung / Two-sided cooling
- 2 - Anodenseitige Kühlung / Anode-sided cooling
- 3 - Kathodenseitige Kühlung / Cathode-sided cooling

Analytische Funktion / Analytical function

$$Z_{thJC} = \sum_{n=1}^{n_{max}} R_{thn} (1 - \text{EXP}(-t/\tau_n))$$