

European Power-Semiconductor and Electronics Company GmbH + Co. KG

Leistungsgleichrichterdioden Power Rectifier Diodes D 849 N

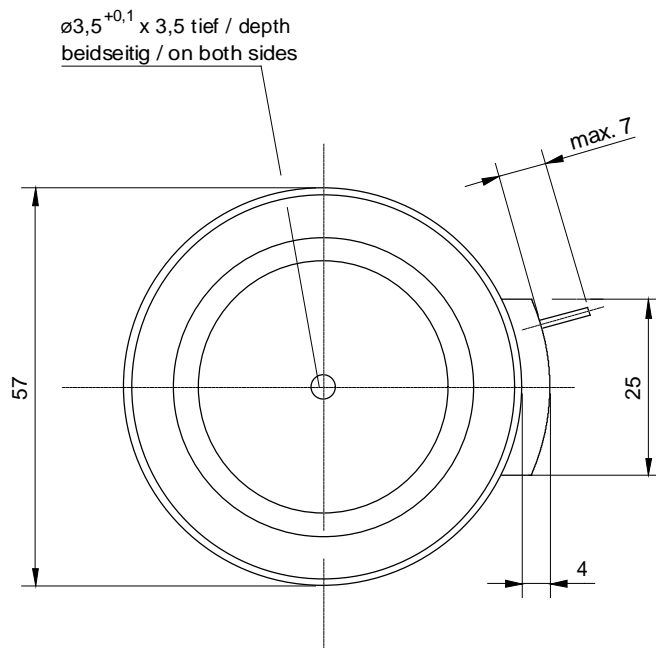
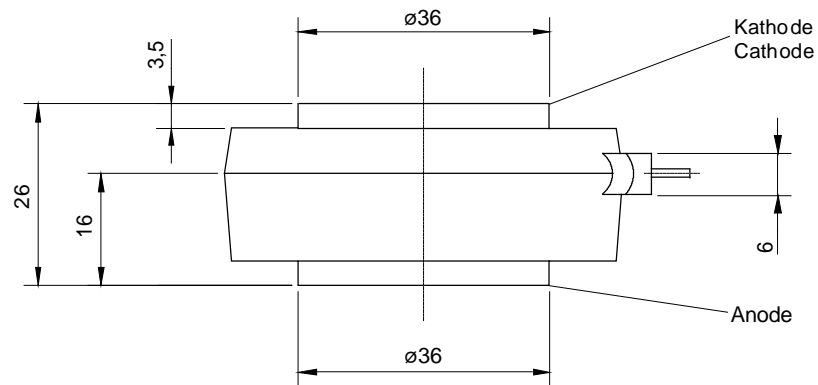

D 849 N

Elektrische Eigenschaften

Electrical properties

Höchstzulässige Werte

Maximum rated values

Periodische Spitzensperrspannung	repetitive peak reverse voltage	$t_{vj} = -40^{\circ}\text{C} \dots t_{vj \max}$	V_{RRM}	2800, 3200 3600, 4000 *	V V
Stoßspitzensperrspannung	non-repetitive peak reverse voltage	$t_{vj} = +25^{\circ}\text{C} \dots t_{vj \max}$	$V_{RSM} = V_{RRM}$	+ 100	V
Durchlaßstrom-Grenzeffektivwert	RMS forward current		I_{FRMSM}	1790	A
Dauergrenzstrom	mean forward current	$t_c = 100^{\circ}\text{C}$	I_{FAVM}	850	A
		$t_c = 64^{\circ}\text{C}$		1140	A
Stoßstrom-Grenzwert	surge forward current	$t_{vj} = 25^{\circ}\text{C}, t_p = 10 \text{ ms}$	I_{FSM}	15,4	kA
		$t_{vj} = t_{vj \max}, t_p = 10 \text{ ms}$		12,8	kA
Grenzlastintegral	$I^2 t$ -value	$t_{vj} = 25^{\circ}\text{C}, t_p = 10 \text{ ms}$	$I^2 t$	1186	kA^2s
		$t_{vj} = t_{vj \max}, t_p = 10 \text{ ms}$		819	kA^2s

Charakteristische Werte

Characteristic values

Durchlaßspannung	on-state voltage	$t_{vj} = t_{vj \max}, i_F = 3,5 \text{ kA}$	V_T	max.	2,62	V
Schleusenspannung	threshold voltage	$t_{vj} = t_{vj \max}$	$V_{T(TO)}$		0,84	V
Ersatzwiderstand	slope resistance	$t_{vj} = t_{vj \max}$	r_T		0,485	$\text{m}\Omega$
Sperrstrom	reverse current	$t_{vj} = t_{vj \max}, V_R = V_{RRM}$	i_R	max.	50	mA

Thermische Eigenschaften

Thermal properties

Innerer Widerstand	thermal resistance, junction to case	beidseitig/two-sided, $\Theta = 180^{\circ} \text{ sin}$	R_{thJC}	max.	0,038	$^{\circ}\text{C/W}$
		beidseitig/two sided, DC		max.	0,035	$^{\circ}\text{C/W}$
		Anode/anode, $\Theta = 180^{\circ} \text{ sin}$		max.	0,064	$^{\circ}\text{C/W}$
		Anode/anode, DC		max.	0,061	$^{\circ}\text{C/W}$
		Kathode/cathode, $\Theta = 180^{\circ} \text{ sin}$		max.	0,085	$^{\circ}\text{C/W}$
		Kathode/cathode, DC		max.	0,082	$^{\circ}\text{C/W}$
Übergangs-Wärmewiderstand	thermal resistance, case to heatsink	beidseitig /two-sided	R_{thCK}	max.	0,005	$^{\circ}\text{C/W}$
		einseitig /single-sided		max.	0,010	$^{\circ}\text{C/W}$
Höchstzul.Sperrschichttemperatur	max. junction temperature		$t_{vj \max}$		160	$^{\circ}\text{C}$
Betriebstemperatur	operating temperature		$t_{c \text{ op}}$		-40...+150	$^{\circ}\text{C}$
Lagertemperatur	storage temperature		t_{stg}		-40...+150	$^{\circ}\text{C}$

Mechanische Eigenschaften

Mechanical properties

Si-Element mit Druckkontakt	Si-pellet with pressure contact	$\varnothing = 38 \text{ mm}$				
Anpreßkraft	clamping force	Gehäuseform/case design T	F		10...24	kN
Gewicht	weight		G	typ.	280	g
Kriechstrecke	creepage distance				36	mm
Feuchteklasse	humidity classification	DIN 40040				C
Schwingfestigkeit	vibration resistance	$f = 50 \text{ Hz}$			50	m/s^2
Maßbild	outline					Seite/page

* Bitte Liefertermin erfragen /Delivery on request

D 849 N

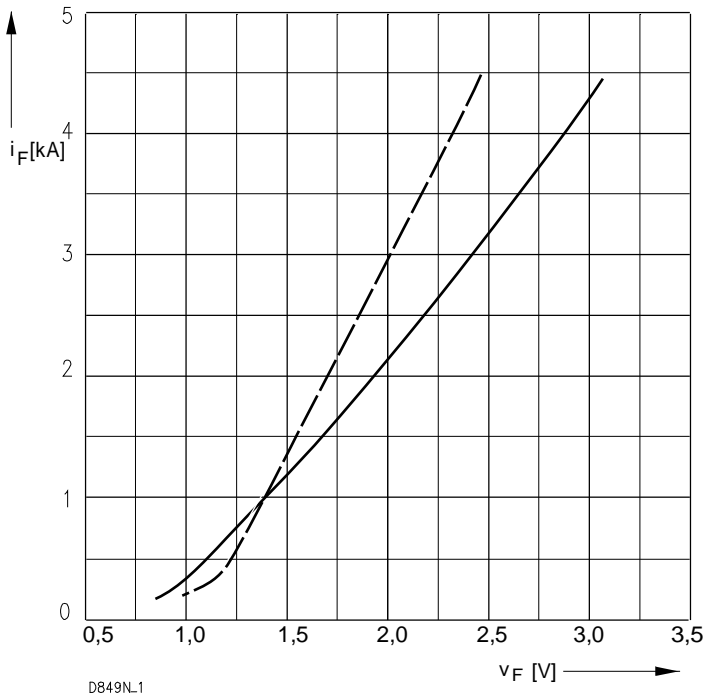

D849N.1

Bild/ Fig. 1
Grenzdurchlaßkennlinie
Limiting forward characteristic $i_F = f(v_F)$
 — $t_j = 160\text{ °C}$
 - - - $t_j = 25\text{ °C}$

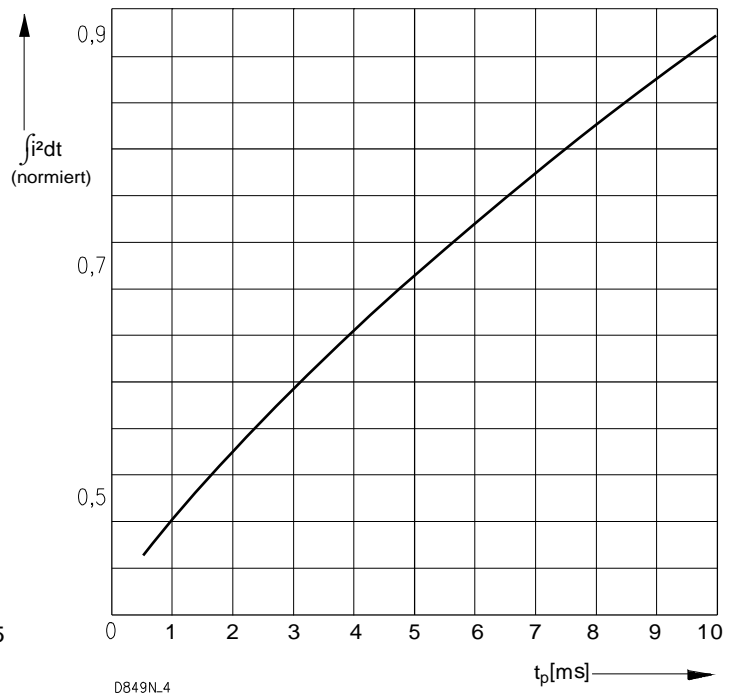

D849N.4

Bild / Fig. 2
Normiertes Grenzlastintegral / Normalized i^2t
 $\int i^2 dt = f(t_p)$

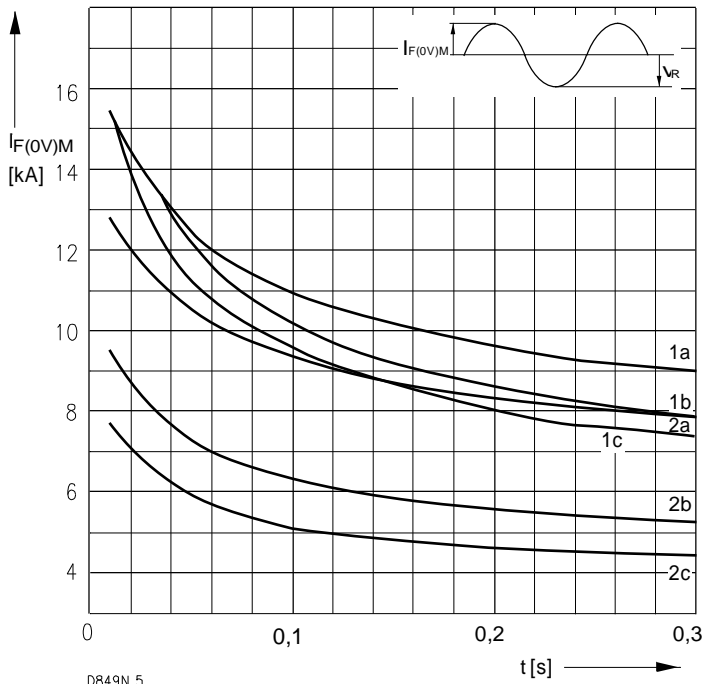

D849N.5

Bild / Fig. 3
Grenzstrom / Maximum overload forward current $I_{F(ov)M} = f(t)$
 1 - $I_{AV(vor)} = 0\text{ A}$; $t_j = t_C = 25\text{ °C}$
 2 - $I_{AV(vor)} = 850\text{ A}$; $t_C = 100\text{ °C}$; $t_j = 160\text{ °C}$
 a - $v_R \leq 50\text{ V}$
 b - $v_R = 0,5\text{ } V_{RRM}$
 c - $v_R = 0,8\text{ } V_{RRM}$

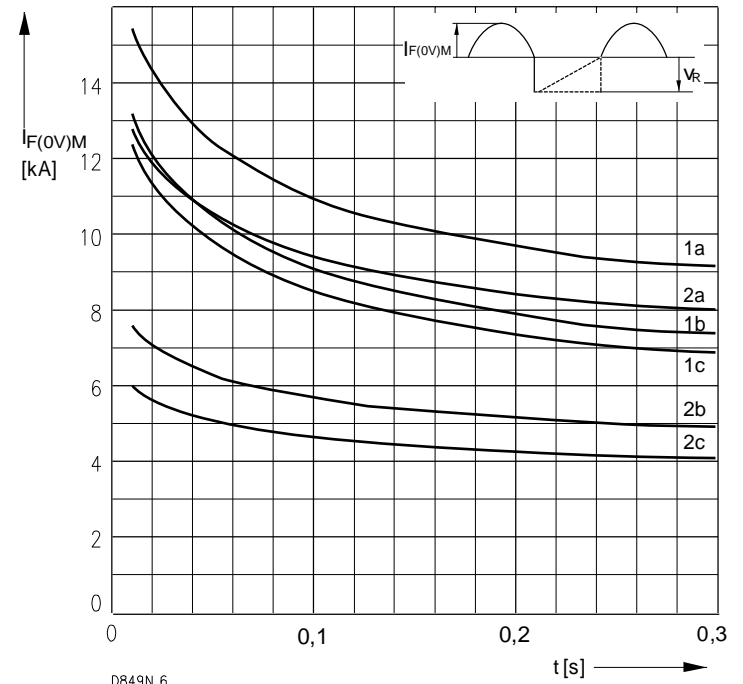

D849N.6

Bild / Fig. 4
Grenzstrom / Maximum overload forward current $I_{F(ov)M} = f(t)$
 1 - $I_{AV(vor)} = 0\text{ A}$; $t_j = t_C = 25\text{ °C}$
 2 - $I_{AV(vor)} = 850\text{ A}$; $t_C = 100\text{ °C}$; $t_j = 160\text{ °C}$
 a - $v_R \leq 50\text{ V}$
 b - $v_R = 0,5\text{ } V_{RRM}$
 c - $v_R = 0,8\text{ } V_{RRM}$

D 849 N



Bild / Fig. 5
 Differenz zwischen den Wärmewiderständen für Pulsstrom und DC
 Difference between the values of thermal resistance for pulse current and DC
 Parameter: Stromkurvenform / Current waveform



Bild / Fig. 6
 Sperrverzögerungsladung / Recovered charge $Q_r = Q - dI/dt$
 $t_{vj} = t_{vjmax}$; $v_R \leq 0,5 V_{RRM}$; $V_{RM} = 0,8 V_{RRM}$
 Beschaltung / Snubber: $C = 1 \mu F$; $R = 3,9 \Omega$
 Parameter: Durchlaßstrom / Forward current i_{FM}

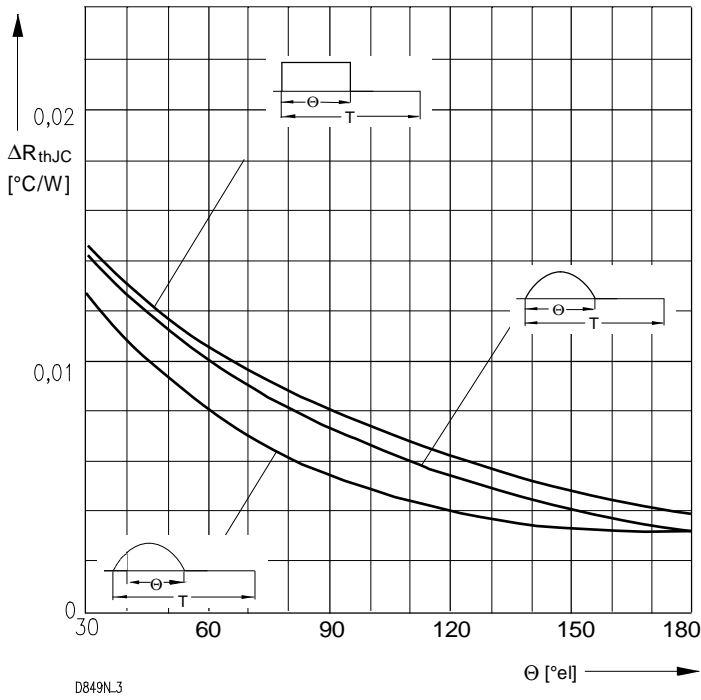

Analytische Elemente des transienten Wärmewiderstandes Z_{thJC} für DC
 Analytical elements of transient thermal impedance Z_{thJC} for DC

Kühlg. Cooling	Pos. n	1	2	3	4	5	6	7
1	$R_{thn} \text{ } ^\circ\text{C/W}$	0,00123	0,00397	0,0041	0,0153	0,0104		
	$\tau_n \text{ [s]}$	0,00152	0,00932	0,0708	0,251	1,79		
2	$R_{thn} \text{ } ^\circ\text{C/W}$	0,00134	0,00466	0,0174	0,0376			
	$\tau_n \text{ [s]}$	0,00159	0,0113	0,177	6,25			
3	$R_{thn} \text{ } ^\circ\text{C/W}$	0,00133	0,00457	0,0165	0,0596			
	$\tau_n \text{ [s]}$	0,00159	0,0111	0,169	7,31			

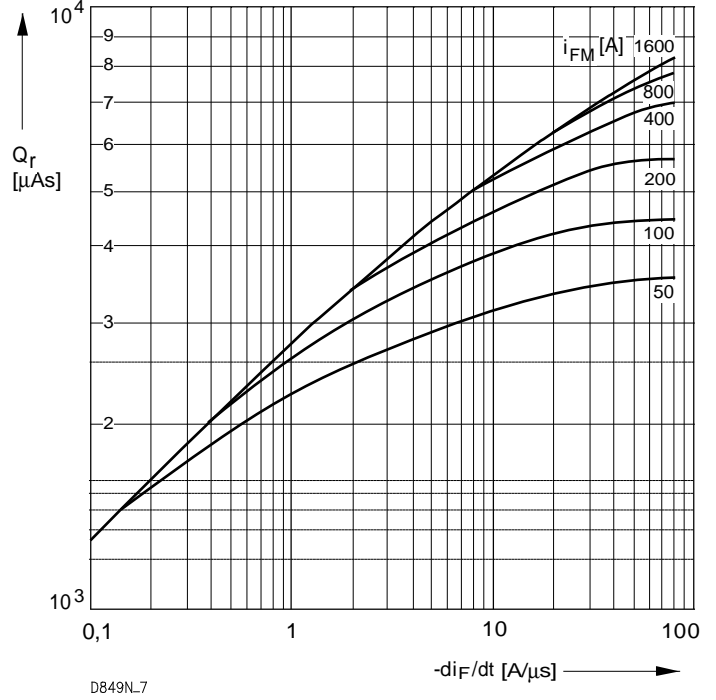
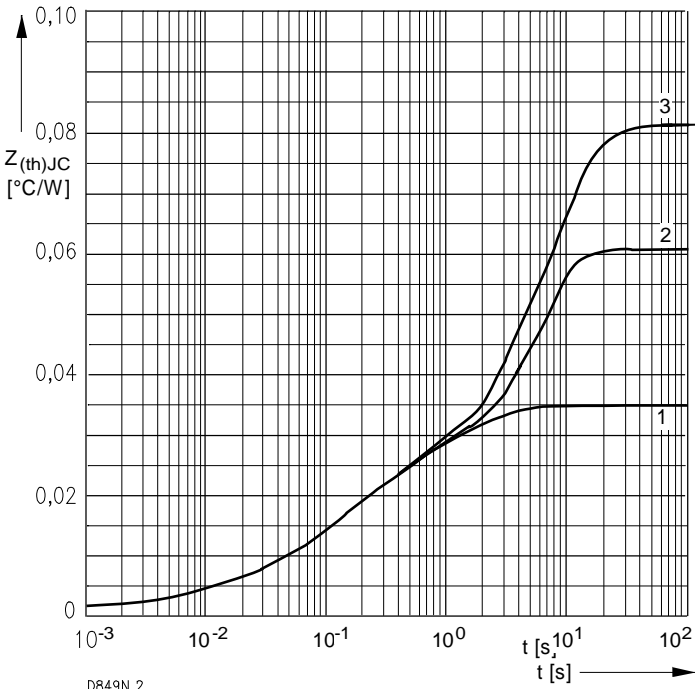
- 1 - Beidseitige Kühlung / Two-sided cooling
- 2 - Anodenseitige Kühlung / Anode-sided cooling
- 3 - Kathodenseitige Kühlung / Cathode-sided cooling

Analytische Funktion / Analytical function

$$Z_{thJC} = \sum_{n=1}^{n_{max}} R_{thn} (1 - \text{EXP}(-t/\tau_n))$$

Bild / Fig. 7
 Transienter innerer Wärmewiderstand $Z_{thJC} = f(t)$, DC
 1 - Beidseitige Kühlung / Two-sided cooling
 2 - Anodenseitige Kühlung / Anode-sided cooling
 3 - Kathodenseitige Kühlung / Cathode-sided cooling