

Technische Information / Technical Information

eupec

Netz-Thyristor
Phase Control Thyristor

T 2479 N 22...28

N



Elektrische Eigenschaften / Electrical properties

Höchstzulässige Werte / Maximum rated values

Vorläufige Daten

Preliminary Data

Periodische Vorwärts- und Rückwärts-Spitzenspannung repetitive peak forward off-state and reverse voltages	$T_{vj} = -40^{\circ}\text{C} \dots T_{vj\text{max}}$	$V_{\text{DRM}}, V_{\text{RRM}}$	2200, 2400 2600, 2800	V
Vorwärts-Stoßspitzenspannung non-repetitive peak forward off-state voltage	$T_{vj} = -40^{\circ}\text{C} \dots T_{vj\text{max}}$	V_{DSM}	2200, 2400 2600, 2800	V
Rückwärts-Stoßspitzenspannung non-repetitive peak reverse voltage	$T_{vj} = +25^{\circ}\text{C} \dots T_{vj\text{max}}$	V_{RSM}	2300, 2500 2700, 2900	V
Durchlaßstrom-Grenzeffektivwert RMSM on-state current		I_{TRSM}	5100	A
Dauergrenzstrom average on-state current	$T_{\text{C}} = 85^{\circ}\text{C}$ $T_{\text{C}} = 65^{\circ}\text{C}$	I_{TAVM}	2480 3250	A A
Stoßstrom-Grenzwert surge current	$T_{vj} = 25^{\circ}\text{C}, t_p = 10\text{ ms}$ $T_{vj} = T_{vj\text{max}}, t_p = 10\text{ ms}$	I_{TSM}	47500 43500	A ¹⁾ A
Grenzlastintegral I^2t -value	$T_{vj} = 25^{\circ}\text{C}, t_p = 10\text{ms}$ $T_{vj} = T_{vj\text{max}}, t_p = 10\text{ms}$	I^2t	11045 9460	$\text{A}^2\text{s} \cdot 10^3$ $\text{A}^2\text{s} \cdot 10^3$
Kritische Stromsteilheit critical rate of rise of on-state current	DIN IEC 747-6 $f=50\text{ Hz}, v_L = 10\text{V}, i_{\text{GM}} = 1\text{ A}$ $di_{\text{G}}/dt = 1\text{ A}/\mu\text{s}$	$(di_{\text{T}}/dt)_{\text{cr}}$	200	$\text{A}/\mu\text{s}$
Kritische Spannungssteilheit critical rate of rise of off-state voltage	$T_{vj} = T_{vj\text{max}}, V_{\text{D}} = 0,67 V_{\text{DRM}}$ 5.Kennbuchstabe / 5th letter F	$(dv_{\text{D}}/dt)_{\text{cr}}$	1000	$\text{V}/\mu\text{s}$

Charakteristische Werte / Characteristic values

Durchlaßspannung on-state voltage	$T_{vj} = T_{vj\text{max}}, i_{\text{T}} = 6500\text{ A}$ $T_{vj} = T_{vj\text{max}}, i_{\text{T}} = 3000\text{ A}$	v_{T}	max. 2,00 max. 1,43	V V
Schleusenspannung threshold voltage	$T_{vj} = T_{vj\text{max}}$	$V_{\text{T(TO)}}$	0,95	V
Ersatzwiderstand slope resistance	$T_{vj} = T_{vj\text{max}}$	r_{T}	0,154	$\text{m}\Omega$
Durchlaßkennlinie on-state voltage $v_{\text{T}} = A + B \times i_{\text{T}} + C \times \ln(i_{\text{T}} + 1) + D \times \sqrt{i_{\text{T}}}$	$T_{vj} = T_{vj\text{max}}$	A=0,8249 B=1,398E-04 C=8,03563E-03 D=2,4542E-03		
Zündstrom gate trigger current	$T_{vj} = 25^{\circ}\text{C}, v_{\text{D}} = 6\text{ V}$	I_{GT}	max. 250	mA
Zündspannung gate trigger voltage	$T_{vj} = 25^{\circ}\text{C}, v_{\text{D}} = 6\text{ V}$	V_{GT}	max. 2,5	V
Nicht zündener Steuerstrom gate non-trigger current	$T_{vj} = T_{vj\text{max}}, v_{\text{D}} = 6\text{ V}$ $T_{vj} = T_{vj\text{max}}, v_{\text{D}} = 0,5 V_{\text{DRM}}$	I_{GD}	max. 10 max. 5	mA mA
Nicht zündene Steuerspannung gate non-trigger voltage	$T_{vj} = T_{vj\text{max}}, v_{\text{D}} = 0,5 V_{\text{DRM}}$	V_{GD}	max. 0,25	mV
Haltestrom holding current	$T_{vj} = 25^{\circ}\text{C}, v_{\text{D}} = 6\text{ V}, R_{\text{A}} = 5\ \Omega$	I_{H}	max. 300	mA
Einraststrom latching current	$T_{vj} = 25^{\circ}\text{C}, v_{\text{D}} = 6\text{ V}, R_{\text{GK}} \geq 10\ \Omega$ $i_{\text{GM}} = 1\text{ A}, di_{\text{G}}/dt = 1\text{ A}/\mu\text{s}$ $t_{\text{g}} = 20\ \mu\text{s}$	I_{L}	max. 1500	mA
Vorwärts- und Rückwärts-Sperrstrom forward off-state and reverse currents	$T_{vj} = T_{vj\text{max}}$ $v_{\text{D}} = V_{\text{DRM}}, v_{\text{R}} = V_{\text{RRM}}$	$i_{\text{D}}, i_{\text{R}}$	max. 250	mA
Zündverzug gate controlled delay time	DIN IEC 747-6 $T_{vj} = 25^{\circ}\text{C}$ $i_{\text{GM}} = 1\text{ A}, di_{\text{G}}/dt = 1\text{ A}/\mu\text{s}$	t_{gd}	max. 4	μs

¹⁾ Gehäusegrenzstrom 38 kA (50Hz Sinushalbwellen). / Current limit of case 38kA (50 Hz sinusoidal half-wave)

Technische Information / Technical Information

eupec

Netz-Thyristor
Phase Control Thyristor

T 2479 N 22...28

N



Elektrische Eigenschaften / Electrical properties

Charakteristische Werte / Characteristic values

Vorläufige Daten

Preliminary Data

Freiwerdezeit circuit commutated turn-off time	$T_{vj} = T_{vj\ max}$, $i_{TM} = I_{TAVM}$ $V_{RM} = 100V$, $V_{DM} = 0,67 V_{DRM}$ $dv_p/dt = 20 V/\mu s$, $-di_T/dt = 10 A/\mu s$ 4. Kennbuchstabe / 4th letter O	t_q	typ. 400	μs
---	--	-------	----------	---------

Thermische Eigenschaften / Thermal properties

Innerer Wärmewiderstand thermal resistance, junction to case	Kühlfläche / cooling surface beidseitig / two-sided, $\Theta = 180^\circ \sin$ beidseitig / two-sided, DC Anode / anode, $\Theta = 180^\circ \sin$ Anode / anode, DC Kathode / cathode, $\Theta = 180^\circ \sin$ Kathode / cathode, DC	R_{thJC}	max. 0,0085 max. 0,0078 max. 0,0152 max. 0,0146 max. 0,0183 max. 0,0169	$^\circ C/W$ $^\circ C/W$ $^\circ C/W$ $^\circ C/W$ $^\circ C/W$ $^\circ C/W$
Übergangs- Wärmewiderstand thermal resistance, case to heatsink	Kühlfläche / cooling surface beidseitig / two-sided einseitig / single-sided	R_{thCK}	max. 0,0025 max. 0,0050	$^\circ C/W$ $^\circ C/W$
Höchstzulässige Sperrschichttemperatur max. junction temperature		$T_{vj\ max}$	125	$^\circ C$
Betriebstemperatur operating temperature		$T_{c\ op}$	-40...125	$^\circ C$
Lagertemperatur storage temperature		T_{stg}	-40...150	$^\circ C$

Mechanische Eigenschaften / Mechanical properties

Gehäuse, siehe Anlage case, see appendix			Seite 3 page 3	
Si-Element mit Druckkontakt, Amplifying-Gate Si-pellet with pressure contact, amplifying gate				
Anpreßkraft clamping force		F	42...95	kN
Gewicht weight		G	typ. 1200	g
Kriechstrecke creepage distance			30	mm
Feuchteklasse humidity classification	DIN 40040		C	
Schwingfestigkeit vibration resistance	f = 50Hz		50	m/s ²

Mit dieser technischen Information werden Halbleiterbauelemente spezifiziert, jedoch keine Eigenschaften zugesichert. Sie gilt in Verbindung mit den zugehörigen Technischen Erläuterungen./ This technical information specifies semiconductor devices but promises no characteristics. It is valid in combination with the belonging technical notes.

Netz-Thyristor
Phase Control Thyristor

T 2479 N 22...28

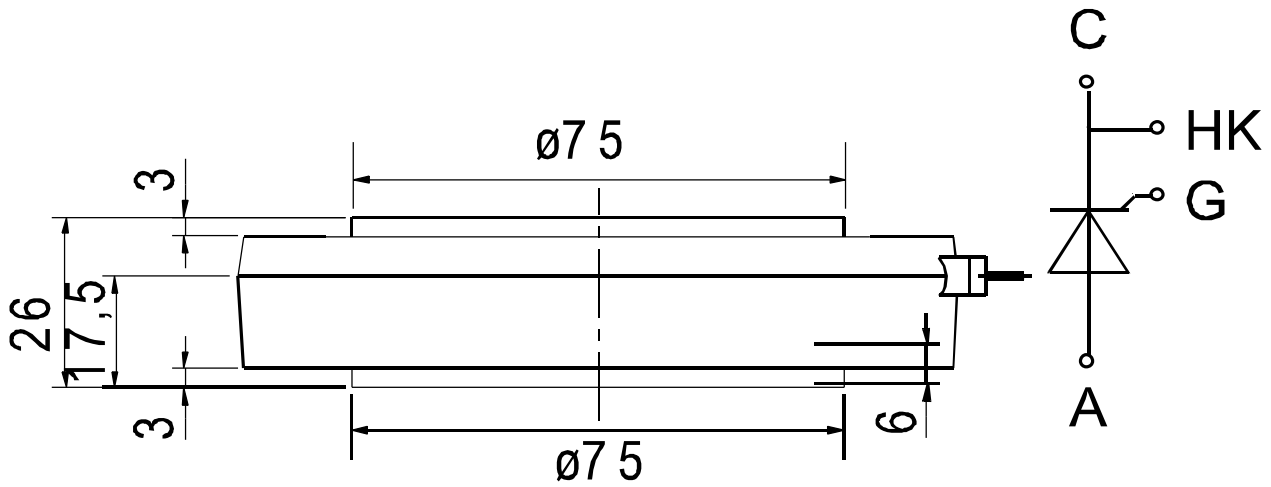

Case DIN 41814-157 A4

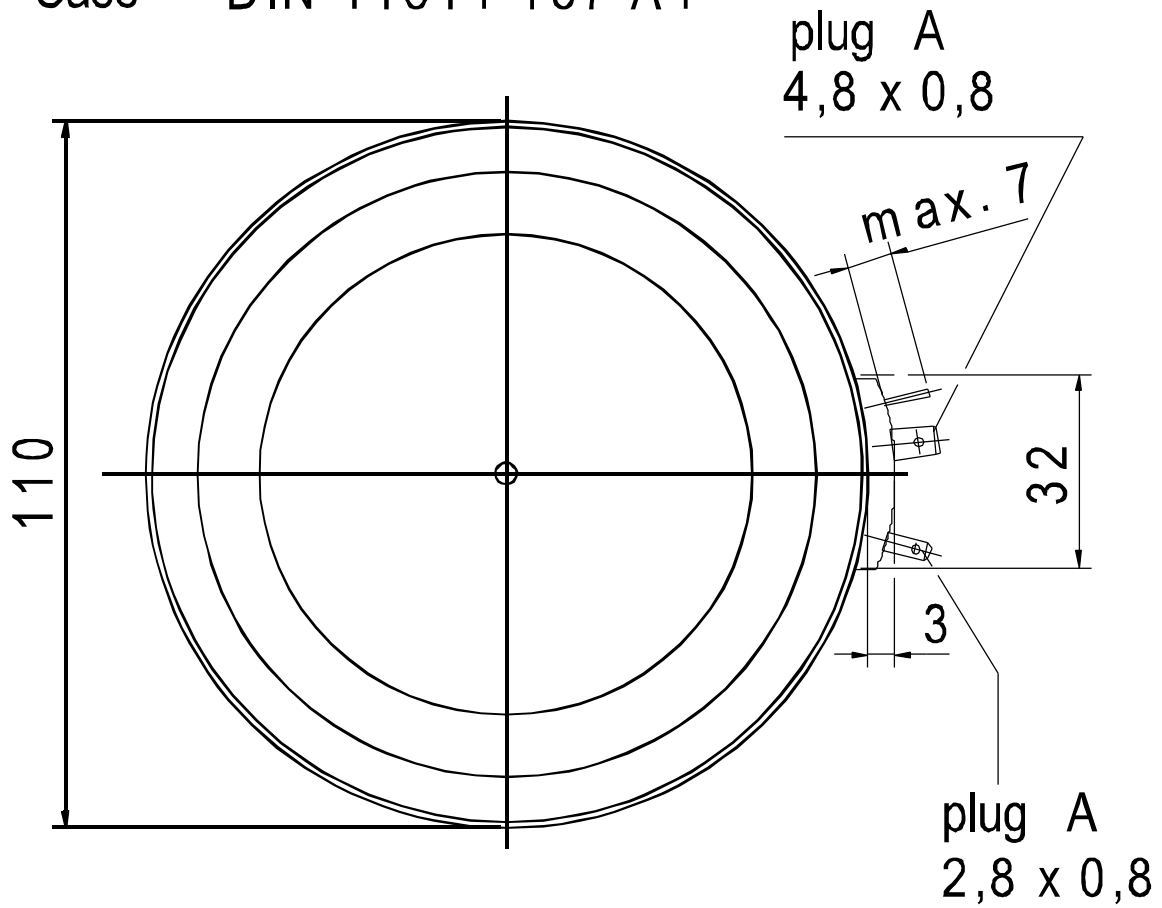

Kühlung cooling	Analytische Elemente des transienten Wärmewiderstandes Z_{thJC} für DC Analytical elements of transient thermal impedance Z_{thJC} for DC							
	Pos.n	1	2	3	4	5	6	7
beidseitig two-sided	R_{thn} [°C/W]	0,000030	0,00039	0,00123	0,0028	0,00338		
	τ_n [s]	0,000055	0,00392	0,0152	0,2068	1,0914		
anodenseitig anode-sided	R_{thn} [°C/W]	0,000009	0,000371	0,0019	0,0013	0,00434	0,00668	
	τ_n [s]	0,000010	0,001820	0,00951	0,135	0,347	1,54	
kathodenseitig cathode-sided	R_{thn} [°C/W]	0,000032	0,000728	0,00302	0,00802	0,0051		
	τ_n [s]	0,000035	0,00341	0,0215	0,135	1,11		

Analytische Funktion / analytical function : $Z_{thJC} = \sum_{n=1}^{n_{max}} R_{thn} (1 - EXP (- t / \tau_n))$

Netz-Thyristor
Phase Control Thyristor

T 2479 N 22...28

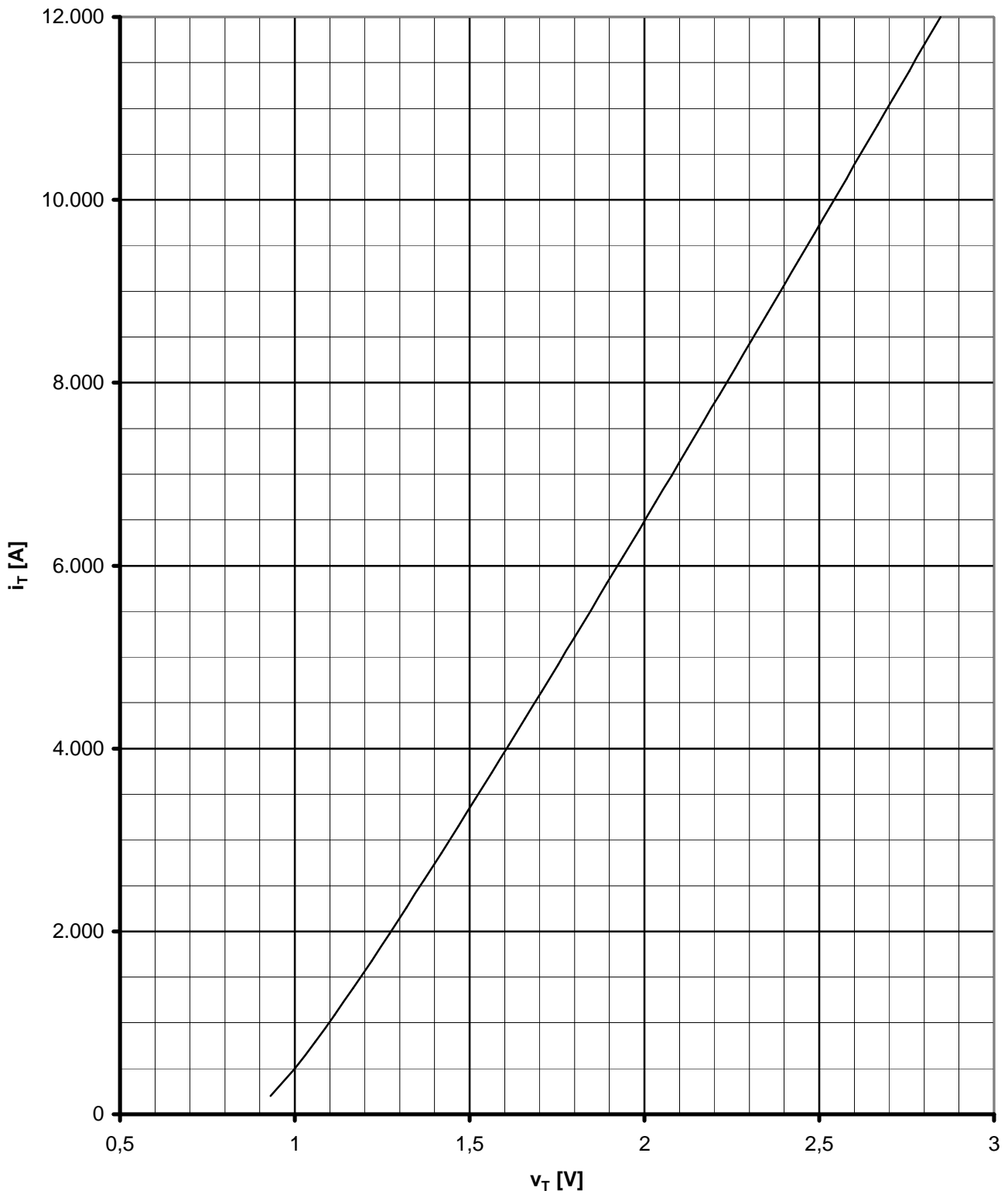
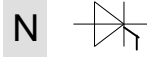

Grenzdurchlaßkennlinie / Limiting on-state characteristic $i_T = f(v_T)$

$T_{vj} = 125 \text{ °C}$

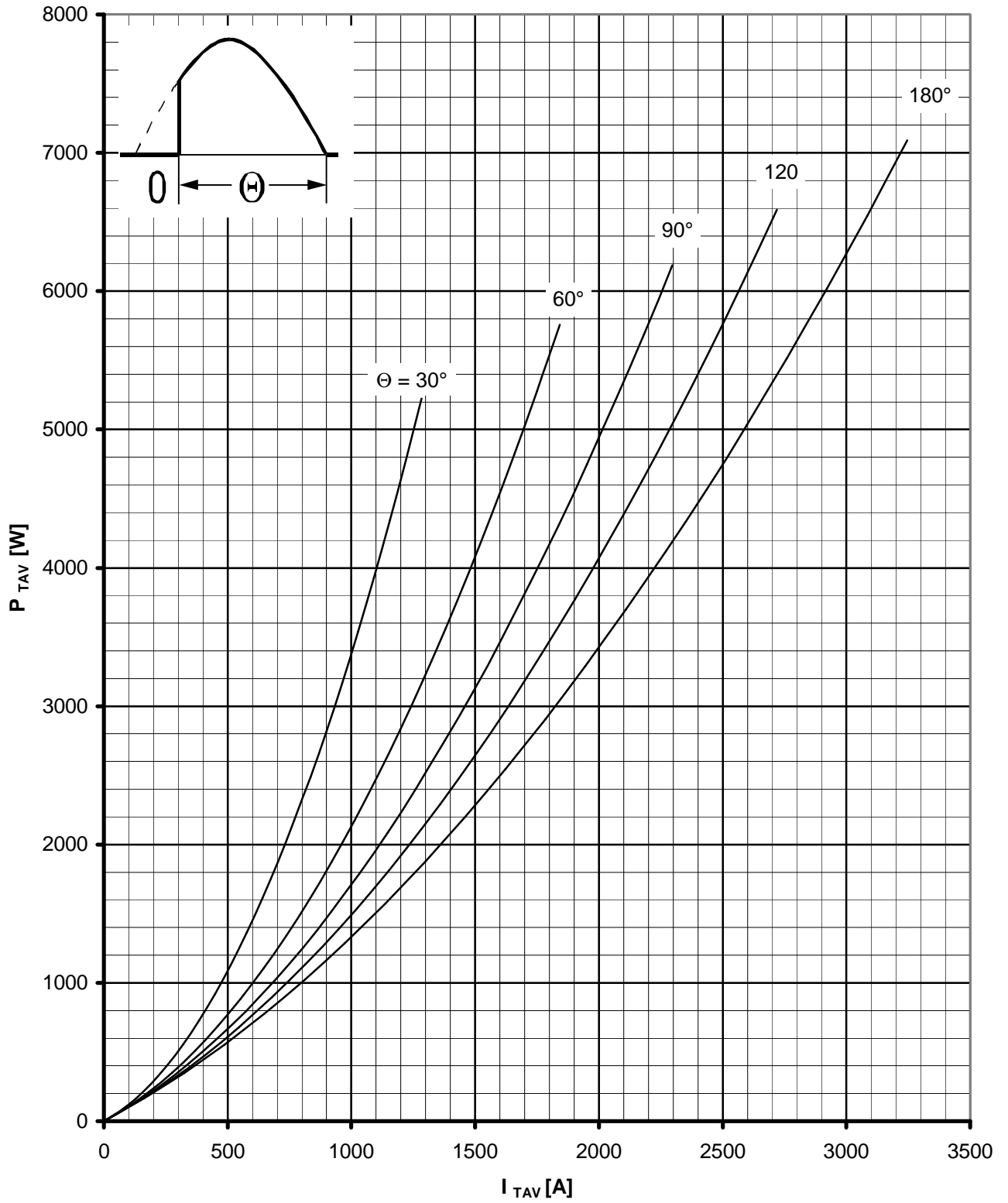

Durchlaßverlustleistung / On-state power loss $P_{TAV} = f(I_{TAV})$

Parameter: Stromflußwinkel θ / current conduction angle θ

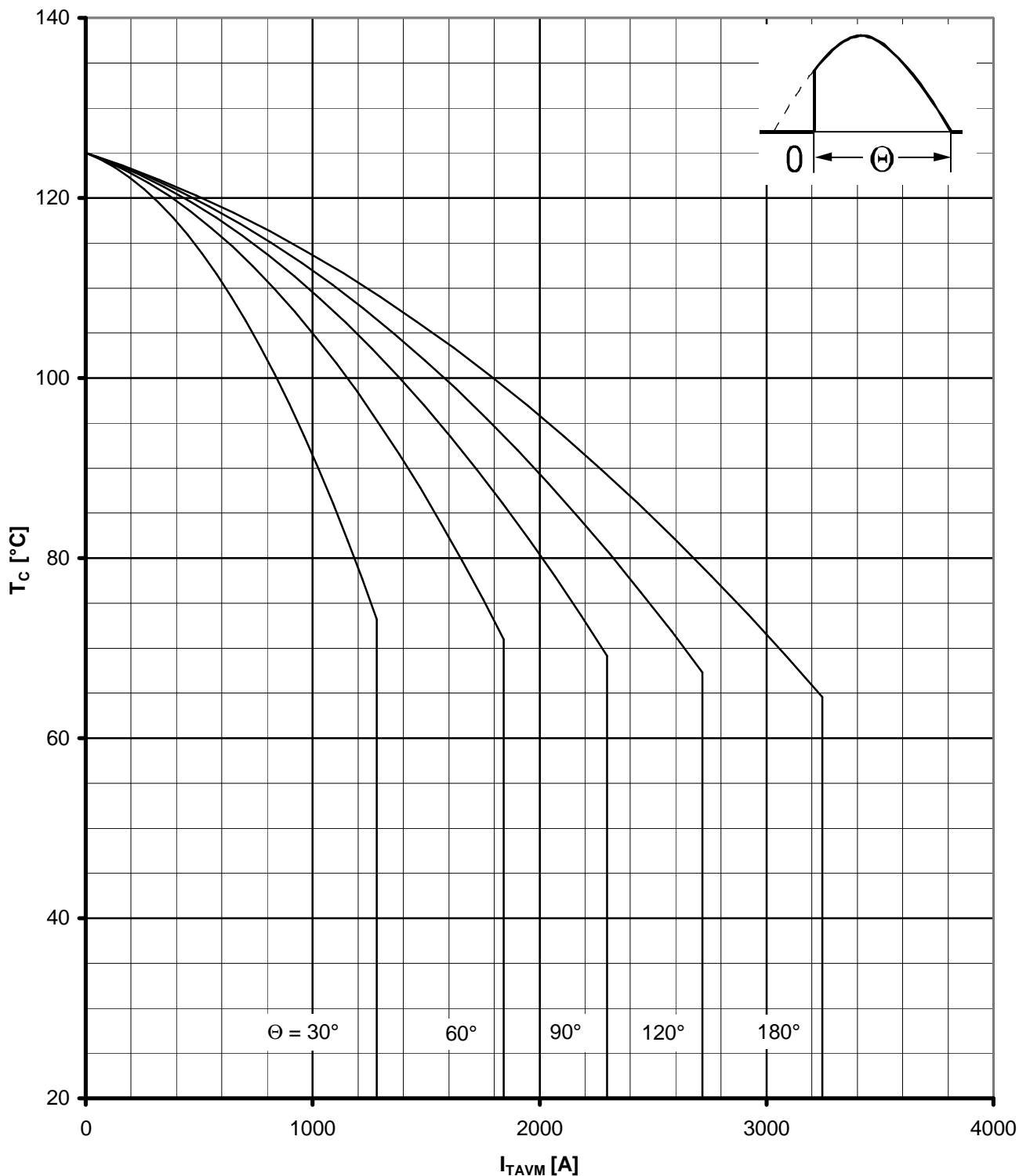

Höchstzulässige Gehäusetemperatur / Maximum allowable case temperature $T_C=f(I_{TAVM})$

Beidseitige Kühlung / Two sided cooling

Parameter: Stromflußwinkel Θ / current conduction angle Θ

Berechnungsgrundlage P_{TAV} (Schaltverluste gesondert berücksichtigen)

Calculation base P_{TAV} (switching losses should be considered separately)

Netz-Thyristor
Phase Control Thyristor

T 2479 N 22... 28

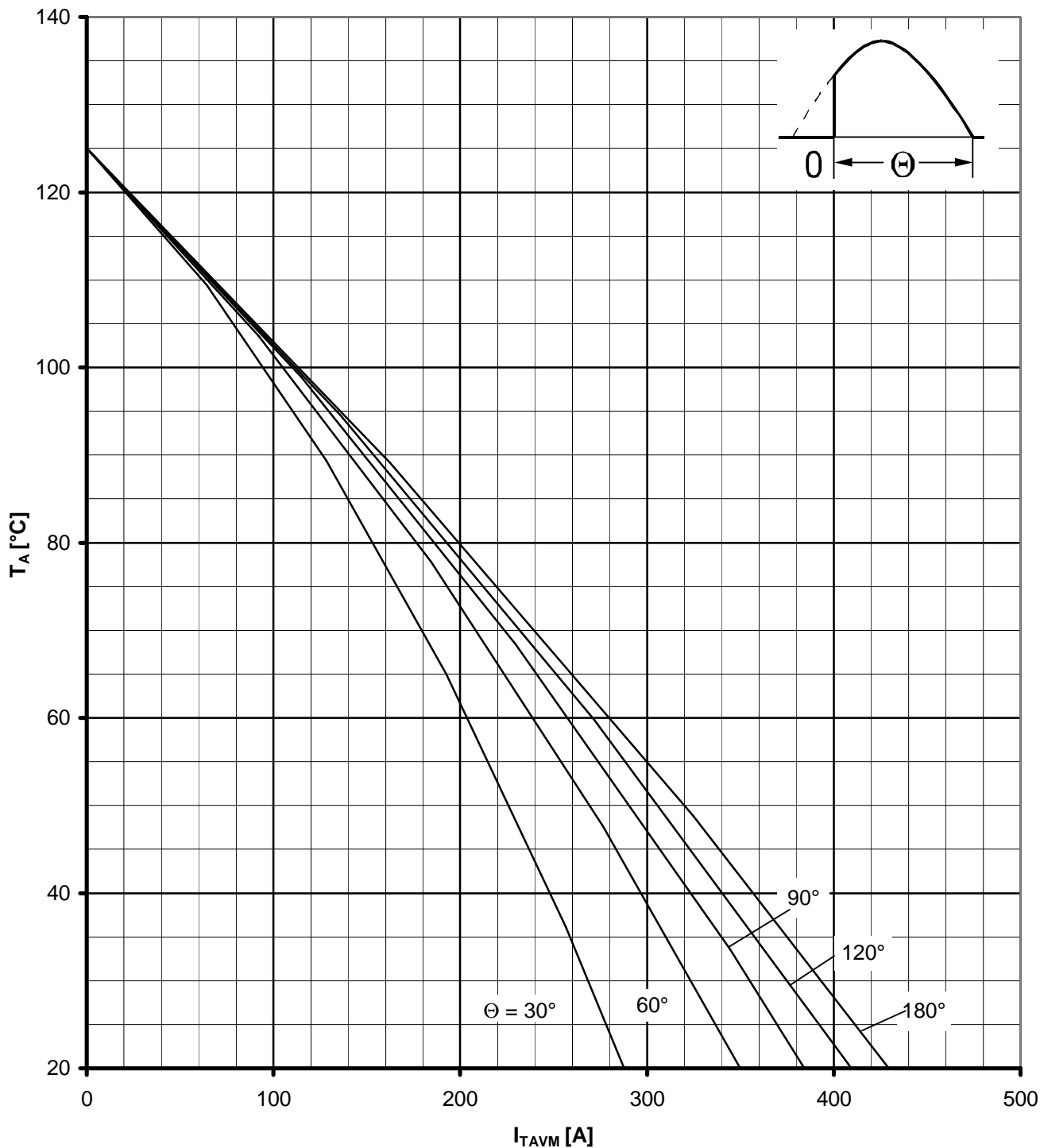
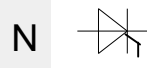

Höchstzulässige Kühlmitteltemperatur / Max. allowable cooling medium temperature $T_A = f(I_{TAVM})$

Luftselbstkühlung / Natural air-cooling

Kühlkörper / Heatsink. K 0.48 F

Parameter: Stromflußwinkel θ / current conduction angle θ

Berechnungsgrundlage P_{TAV} (Schaltverluste gesondert berücksichtigen)

Calculation base P_{TAV} (switching losses should be considered separately)

Netz-Thyristor
Phase Control Thyristor

T 2479 N 22...28

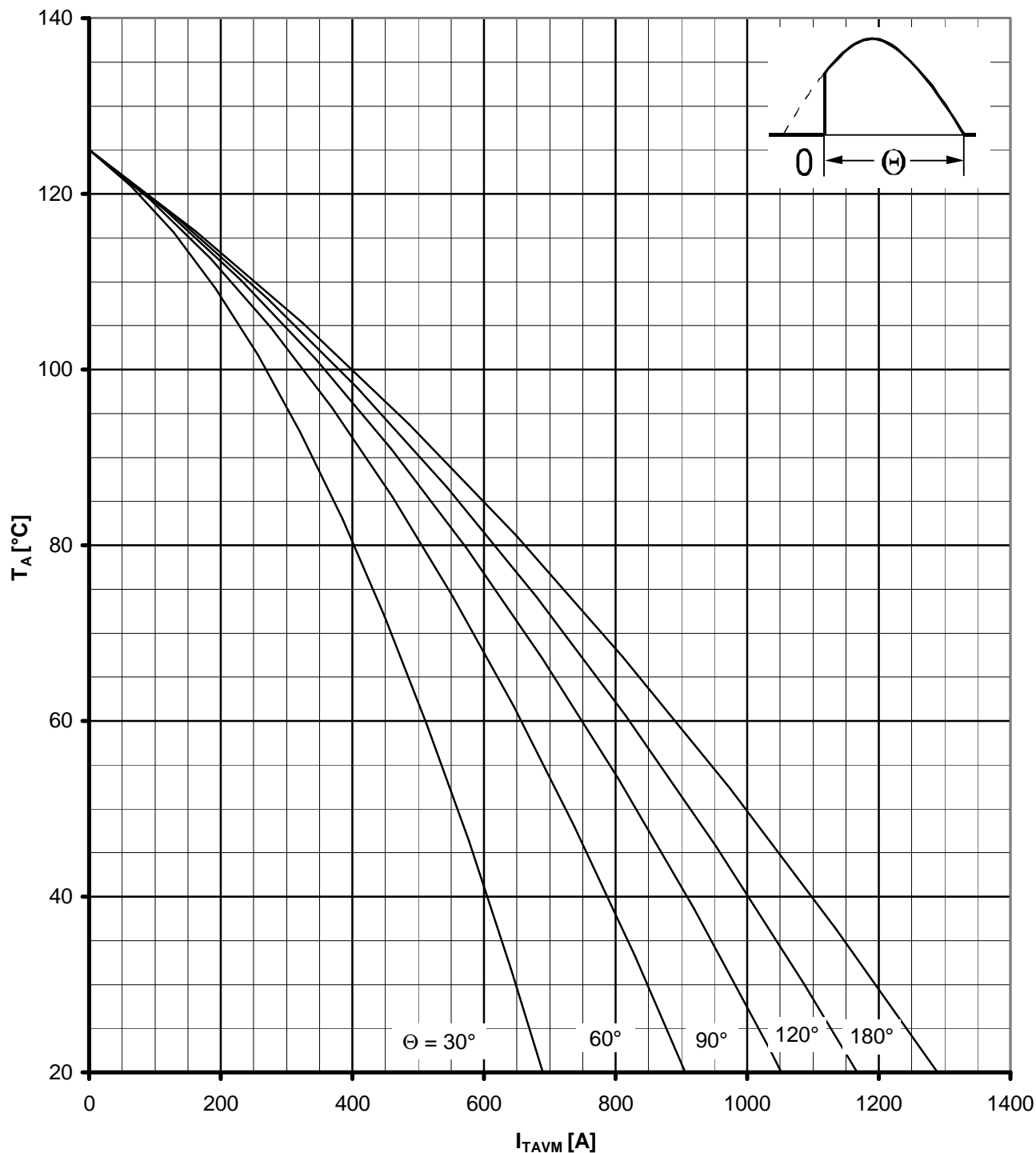
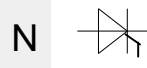

Höchstzulässige Kühlmitteltemperatur / Max. allowable cooling medium temperature $T_A = f(I_{TAVM})$

Verstärkte Luftkühlung / Forced air-cooling

Kühlkörper / Heatsink. $K 0.48F$, $V_L = 120$ l/s

Parameter: Stromflußwinkel θ / current conduction angle θ

Berechnungsgrundlage P_{TAV} (Schaltverluste gesondert berücksichtigen)

Calculation base P_{TAV} (switching losses should be considered separately)

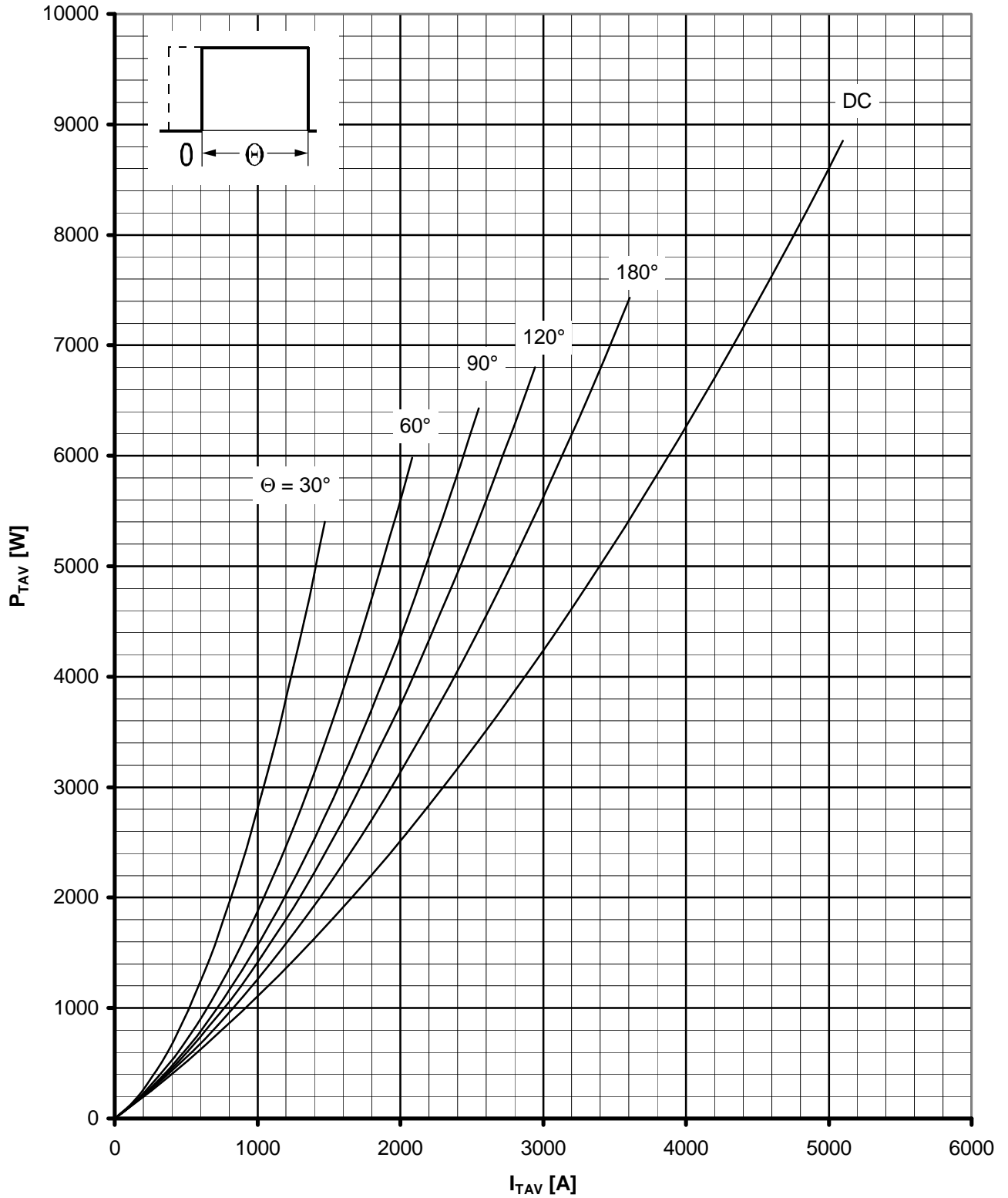

Durchlaßverlustleistung / On-state power loss $P_{TAV} = f(I_{TAV})$
 Parameter: Stromflußwinkel θ / Current conduction angle θ

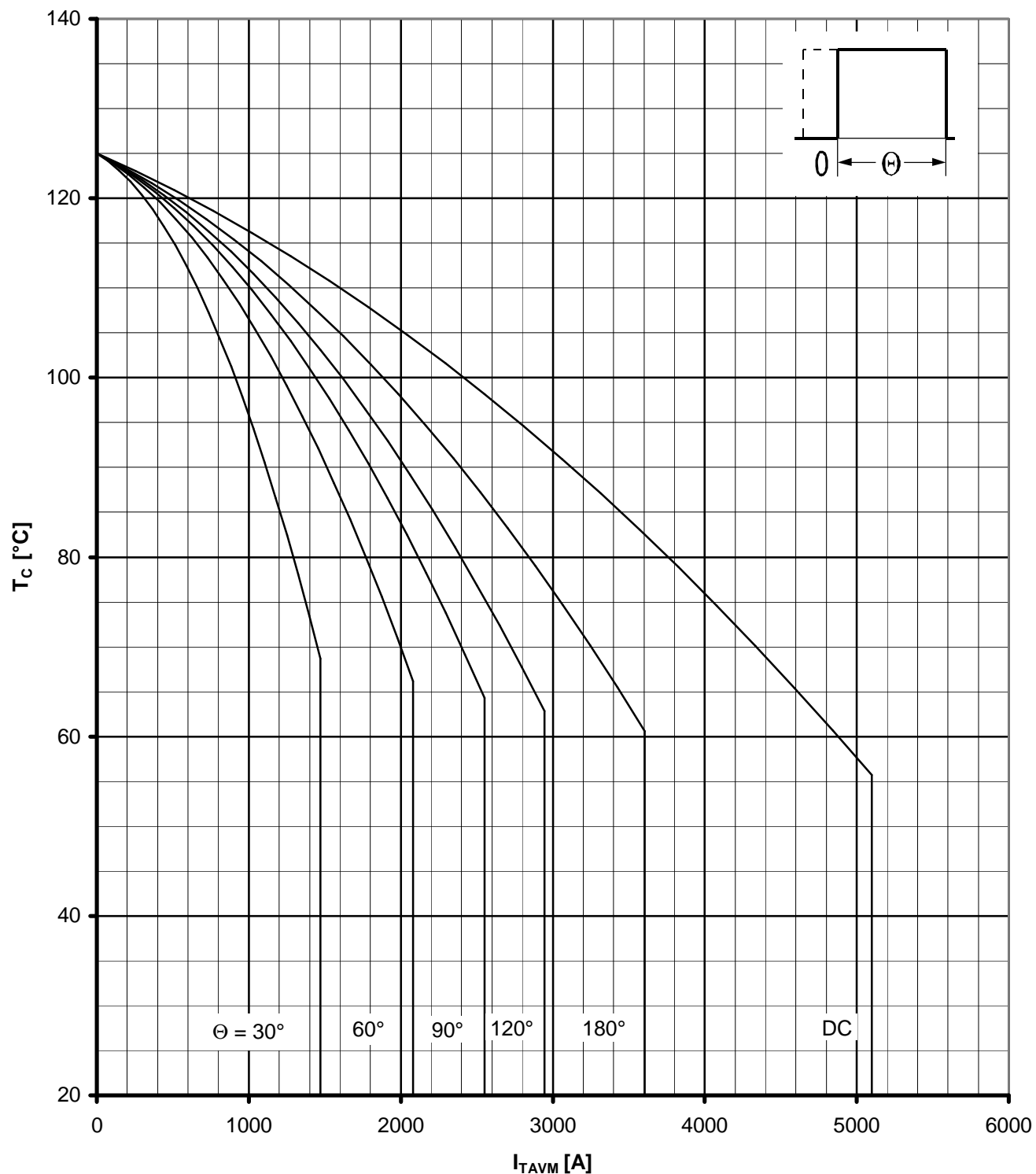

Höchstzulässige Gehäusetemperatur / Maximum allowable case temperature $T_C=f(I_{TAVM})$

Beidseitige Kühlung / two sided cooling

Parameter: Stromflußwinkel Θ / current conduction angle Θ

Berechnungsgrundlage P_{TAV} (Schaltverluste gesondert berücksichtigen)

Calculation base P_{TAV} (switching losses should be considered separately)

Netz-Thyristor
Phase Control Thyristor

T 2479 N 22... 28

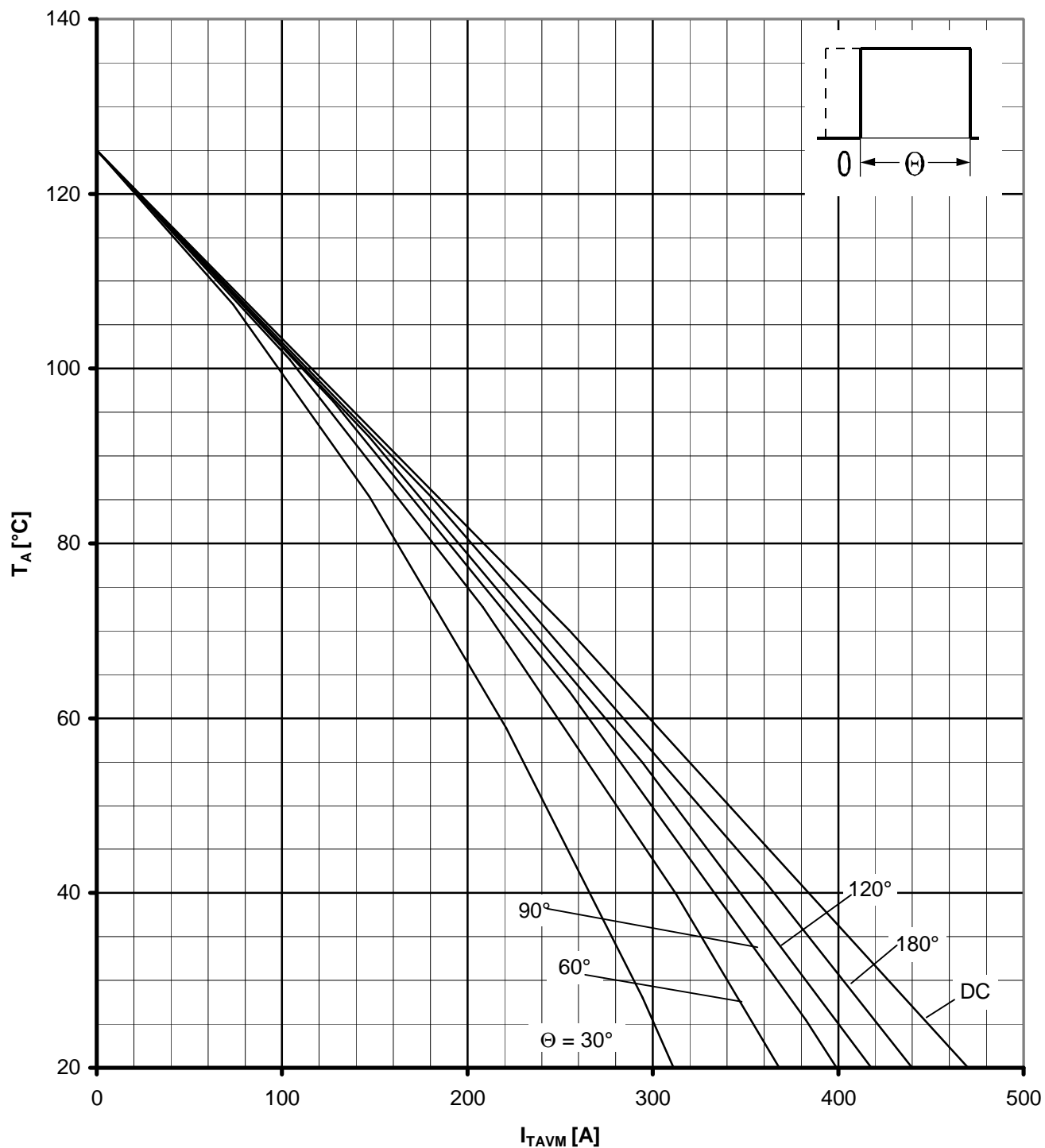
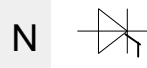

Höchstzulässige Kühlmitteltemperatur / Max. allowable cooling medium temperature $T_A = f(I_{TAVM})$

Luftselbstkühlung / Natural air-cooling

Kühlkörper / Heatsink. K 0.48 F

Parameter: Stromflußwinkel θ / current conduction angle θ

Berechnungsgrundlage P_{TAV} (Schaltverluste gesondert berücksichtigen)

Calculation base P_{TAV} (switching losses should be considered separately)

Netz-Thyristor
Phase Control Thyristor

T 2479 N 22...28

N

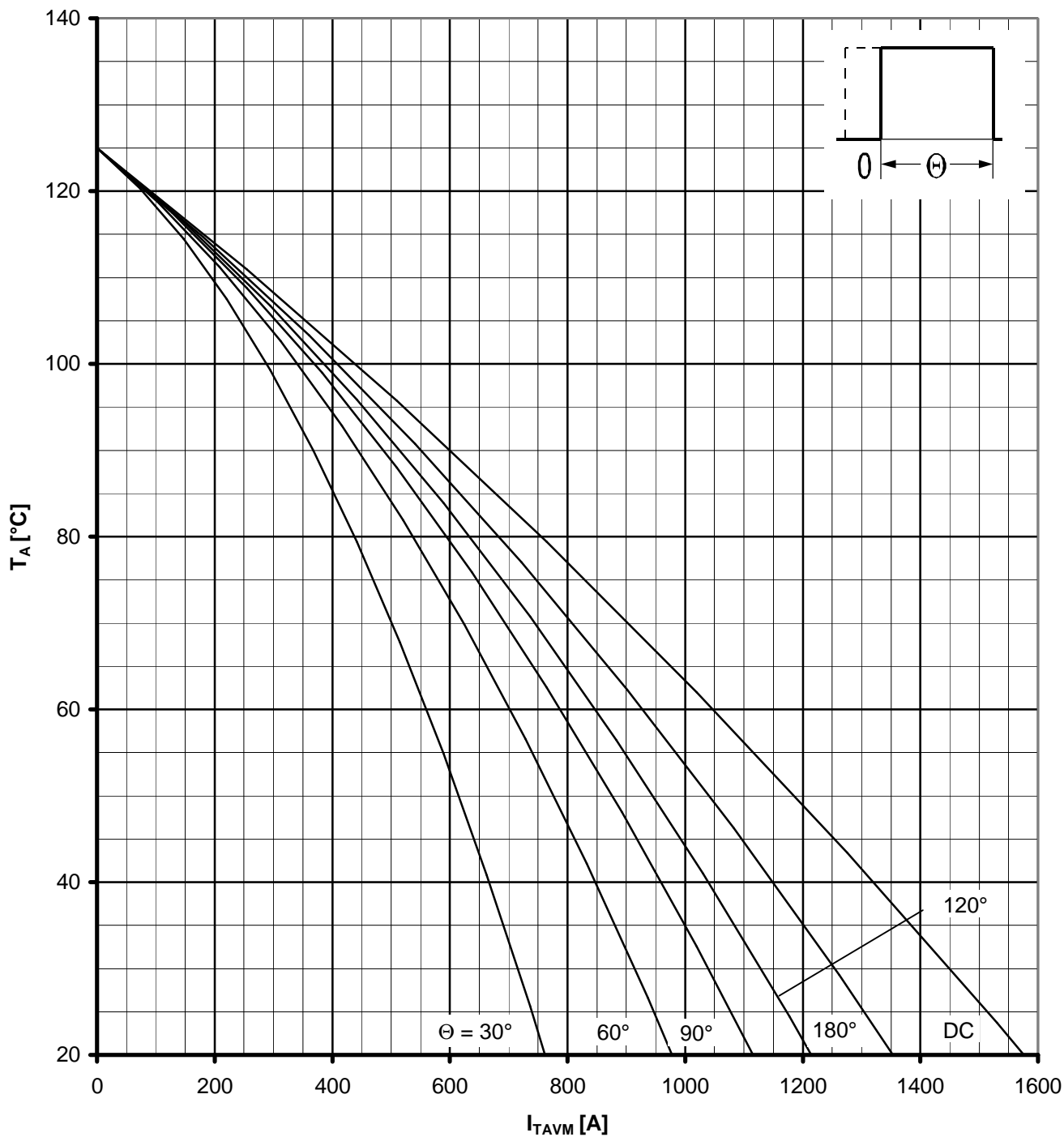

Höchstzulässige Kühlmitteltemperatur / Max. allowable cooling medium temperature $T_A = f(I_{TAVM})$

Verstärkte Luftkühlung / Forced air-cooling

Kühlkörper / Heatsink. $K 0.48F$, $V_L = 120$ l/s

Parameter: Stromflußwinkel θ / current conduction angle θ

Berechnungsgrundlage P_{TAV} (Schaltverluste gesondert berücksichtigen)

Calculation base P_{TAV} (switching losses should be considered separately)

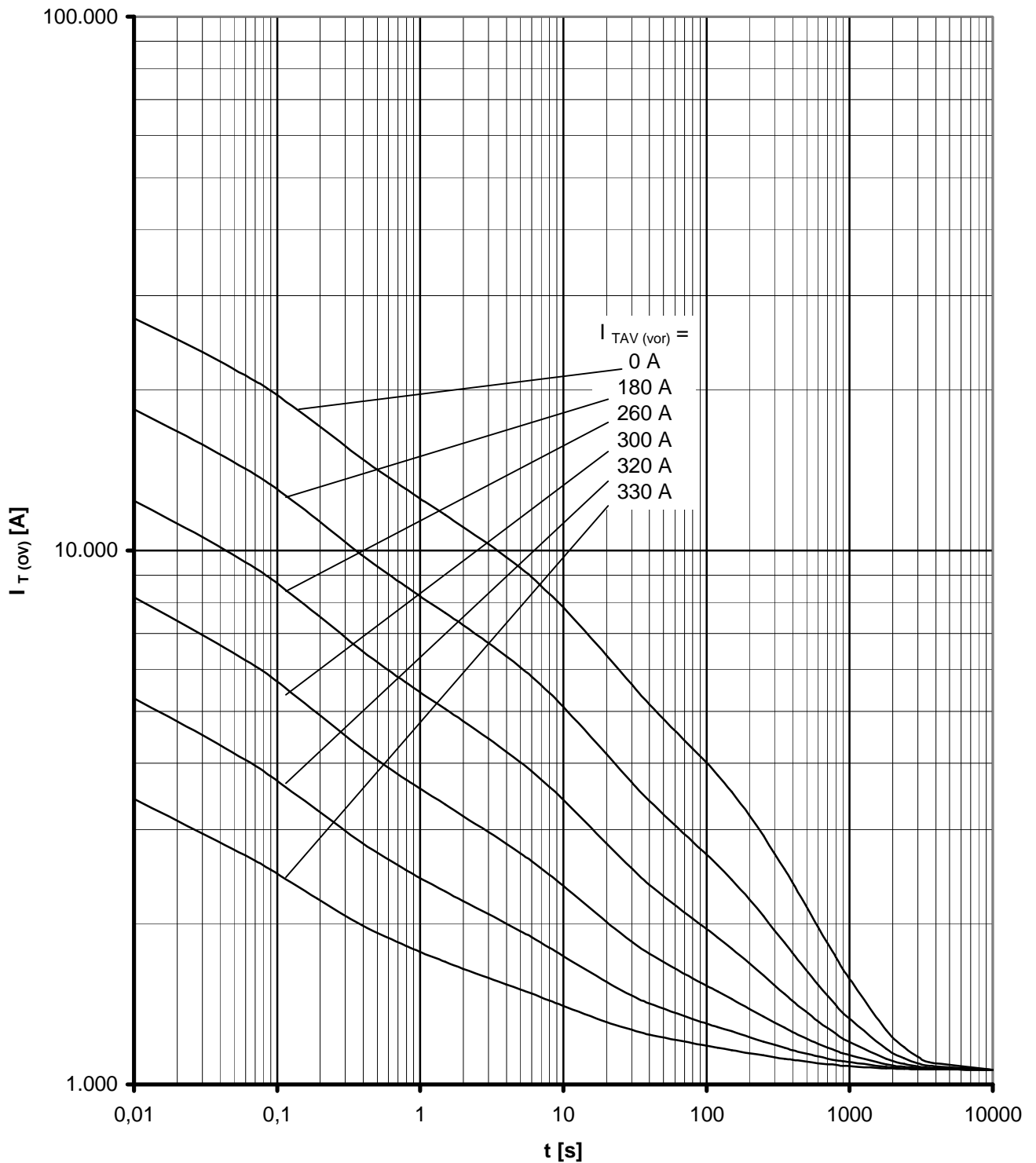

Überstrom / Overload on-state current $I_{T(OV)} = f(t)$

Luftselbstkühlung / Natural cooling K 0.48F

$T_A = 45^\circ\text{C}$

Parameter: Vorlaststrom / pre-load current $I_{TAV(vor)}$

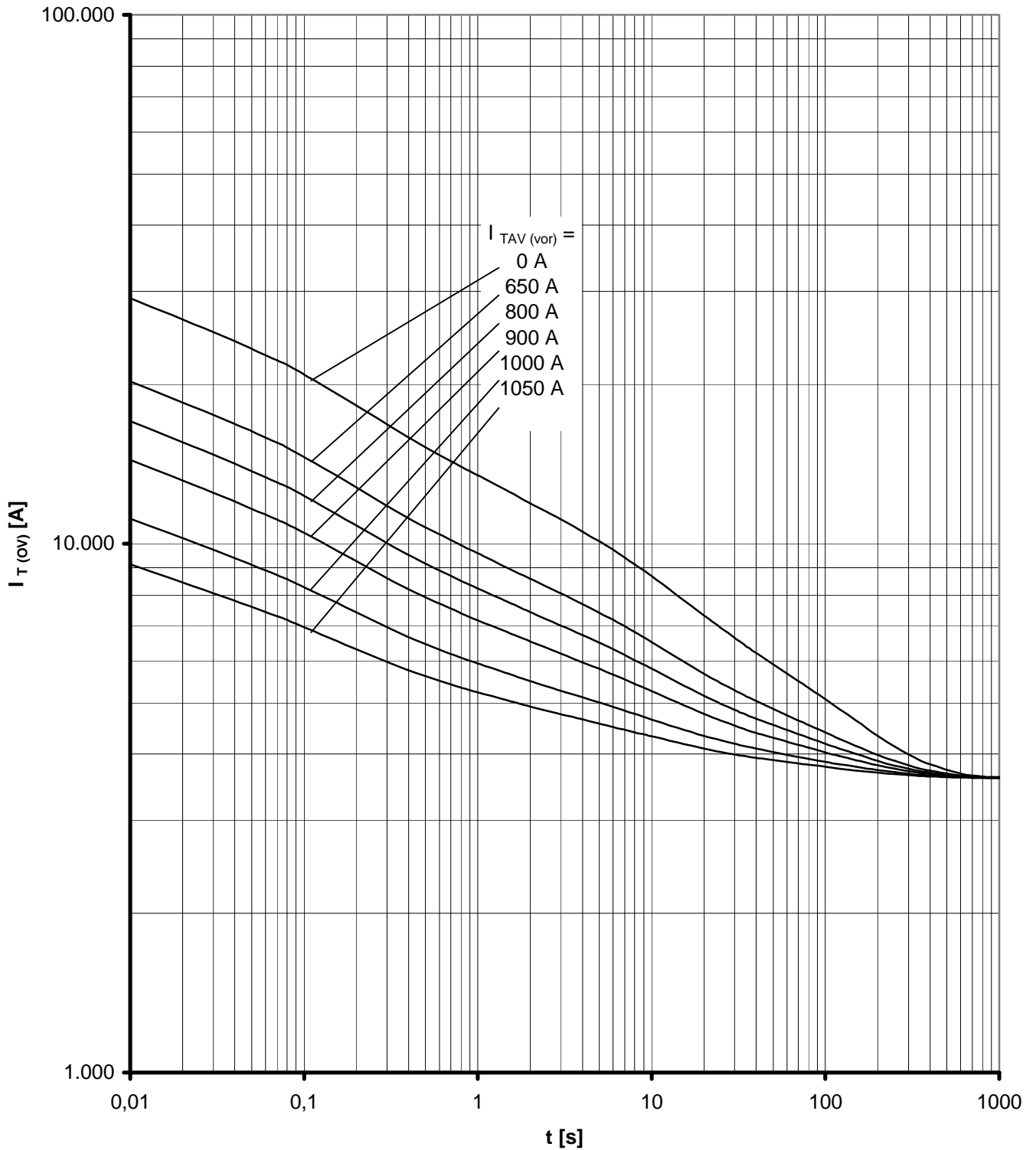

Überstrom / Overload on-state current $I_{T(OV)} = f(t)$

Verstärkte Kühlung / Forced cooling K 0.48F

$T_A = 35^\circ\text{C}$, $V_L = 120 \text{ l/s}$

Parameter: Vorlaststrom / pre-load current $I_{TAV(vor)}$

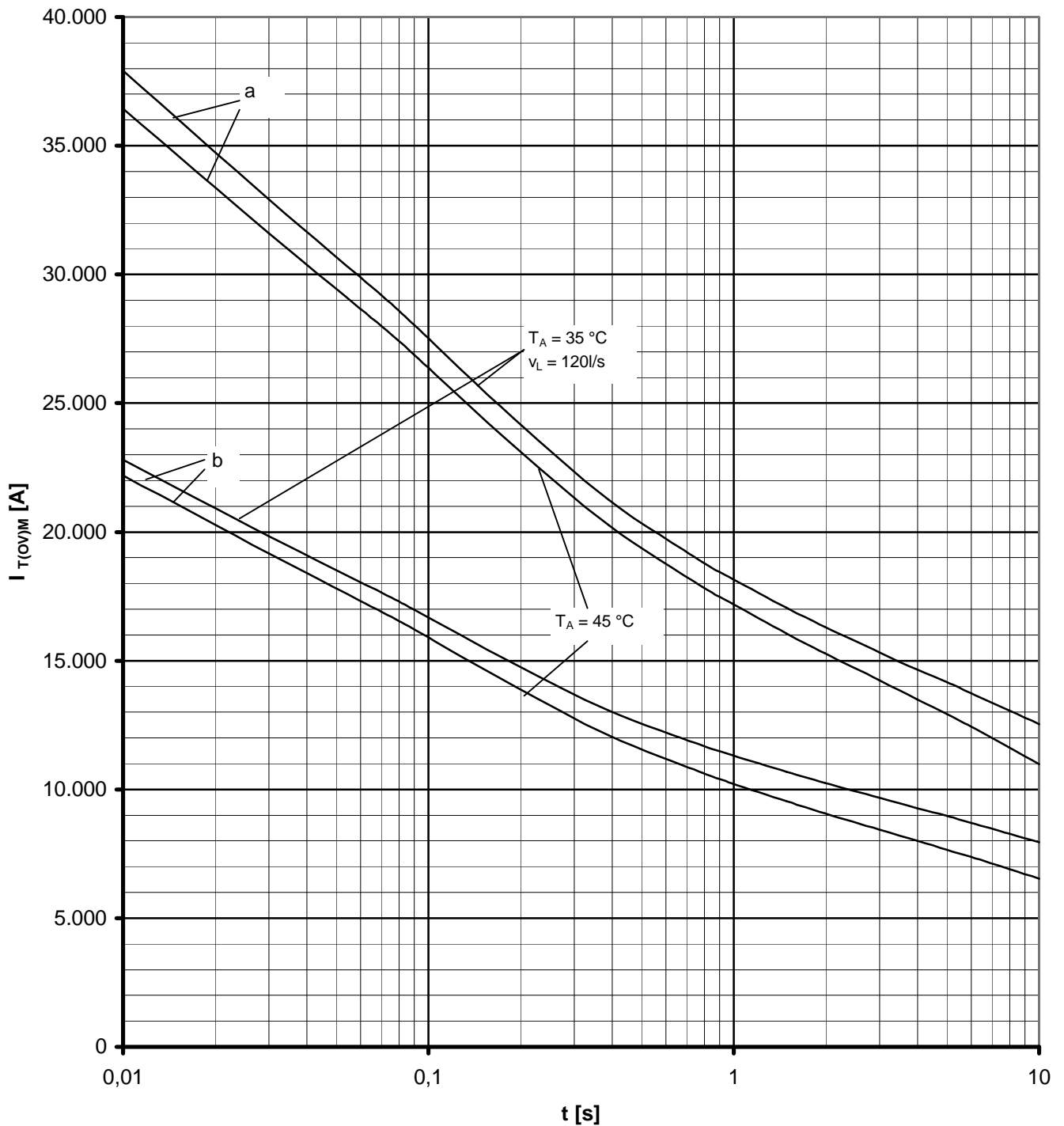

Grenzstrom / Max. overload on-state current $I_{T(OV)M} = f(t)$, $v_{RM} = 0,8 V_{RRM}$

Kühlkörper / Heatsink: K 0.48F

Belastung aus / Surge current occurs:

a - Leerlauf / No-load conditions

b - Betrieb mit Dauergrenzstrom / During operation at max. average on-state current I_{TAVM}

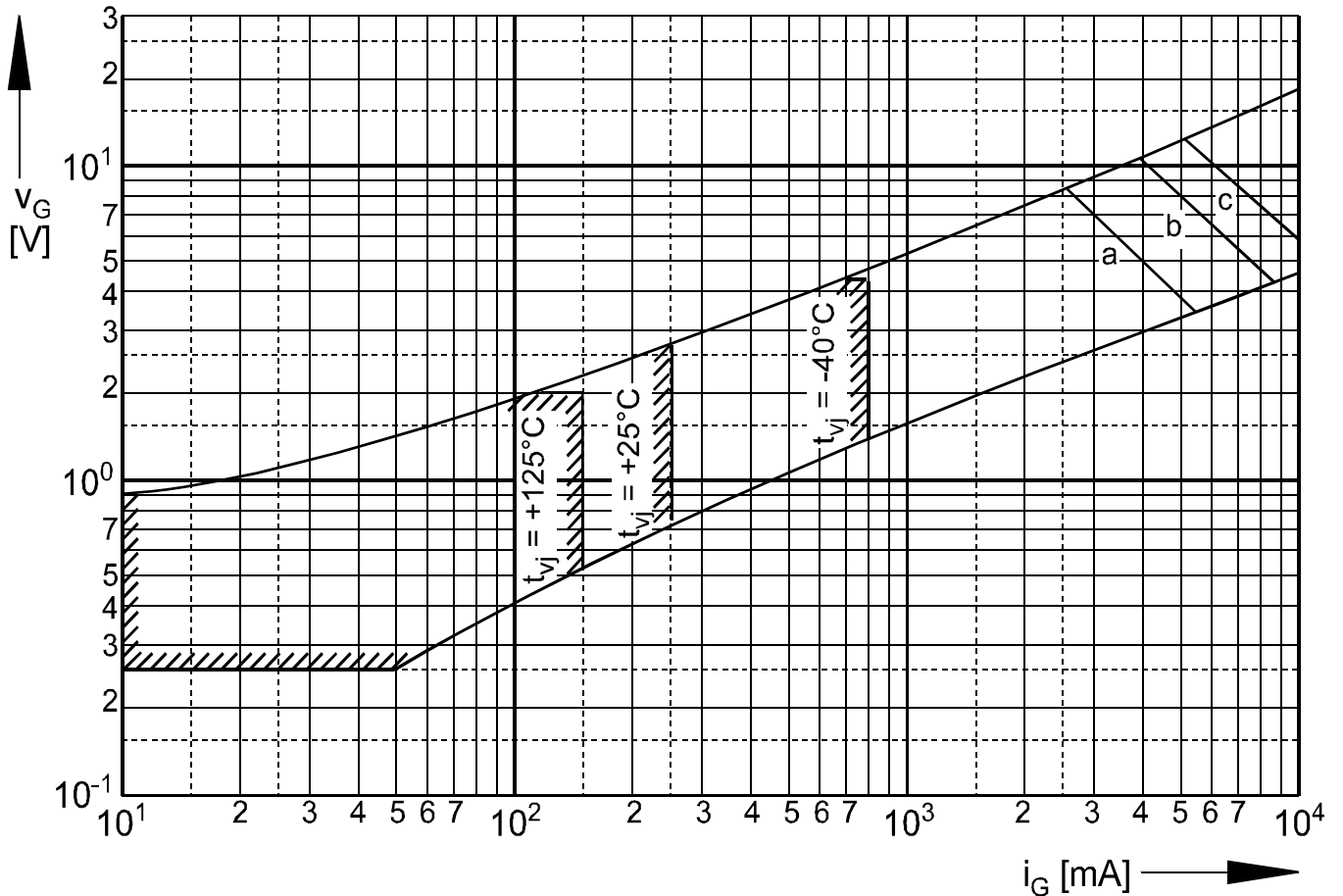

Steuercharakteristik $v_G = f(i_G)$ mit Zündbereichen für $V_D = 6\text{ V}$

Gate characteristic $v_G = f(i_G)$ with triggering area for $V_D = 6\text{ V}$

Höchstzulässige Spitzensteuerverlustleistung / Maximum rated

peak gate power dissipation $PGM = f(t_g)$:

a - 20W/10ms b - 40W/1ms c - 60/0,5ms

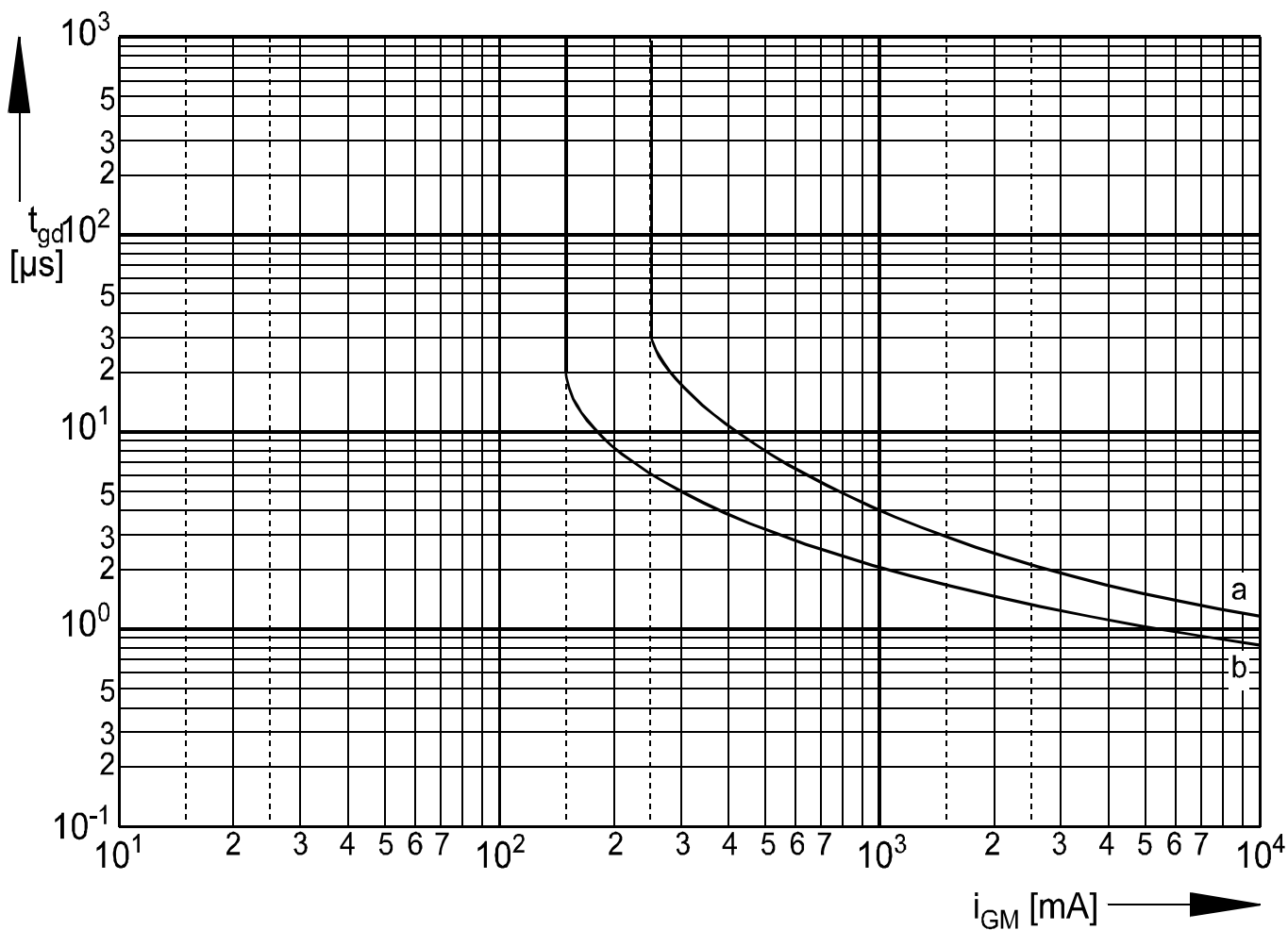

Zündverzögerung / Gate controlled delay time $t_{gd} = f(i_G)$

$T_{vj} = 25^\circ\text{C}$, $di_G/dt = i_{GM} / 1\mu\text{s}$

a - maximaler Verlauf / limiting characteristic

b - typischer Verlauf / typical characteristic

Netz-Thyristor
Phase Control Thyristor

T 2479 N 22...28

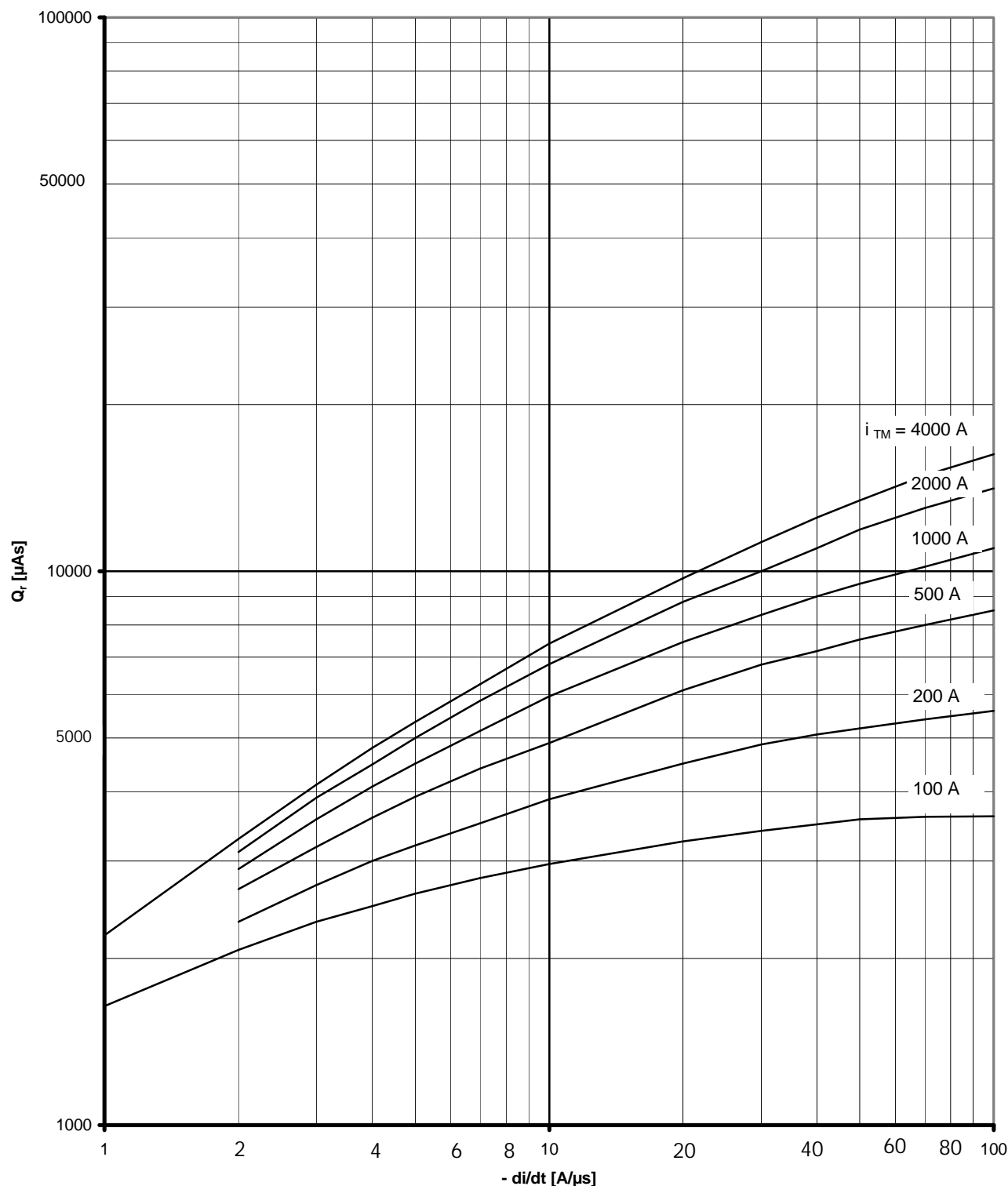

Sperrverzögerungsladung / Recovered charge $Q_r = f(-di/dt)$

$T_{vj} = T_{vj\ max}$, $V_R \leq 0,5 V_{RRM}$, $V_{RM} \leq 0,8 V_{RRM}$

Parameter: Durchlaßstrom / On-state current i_{TM}

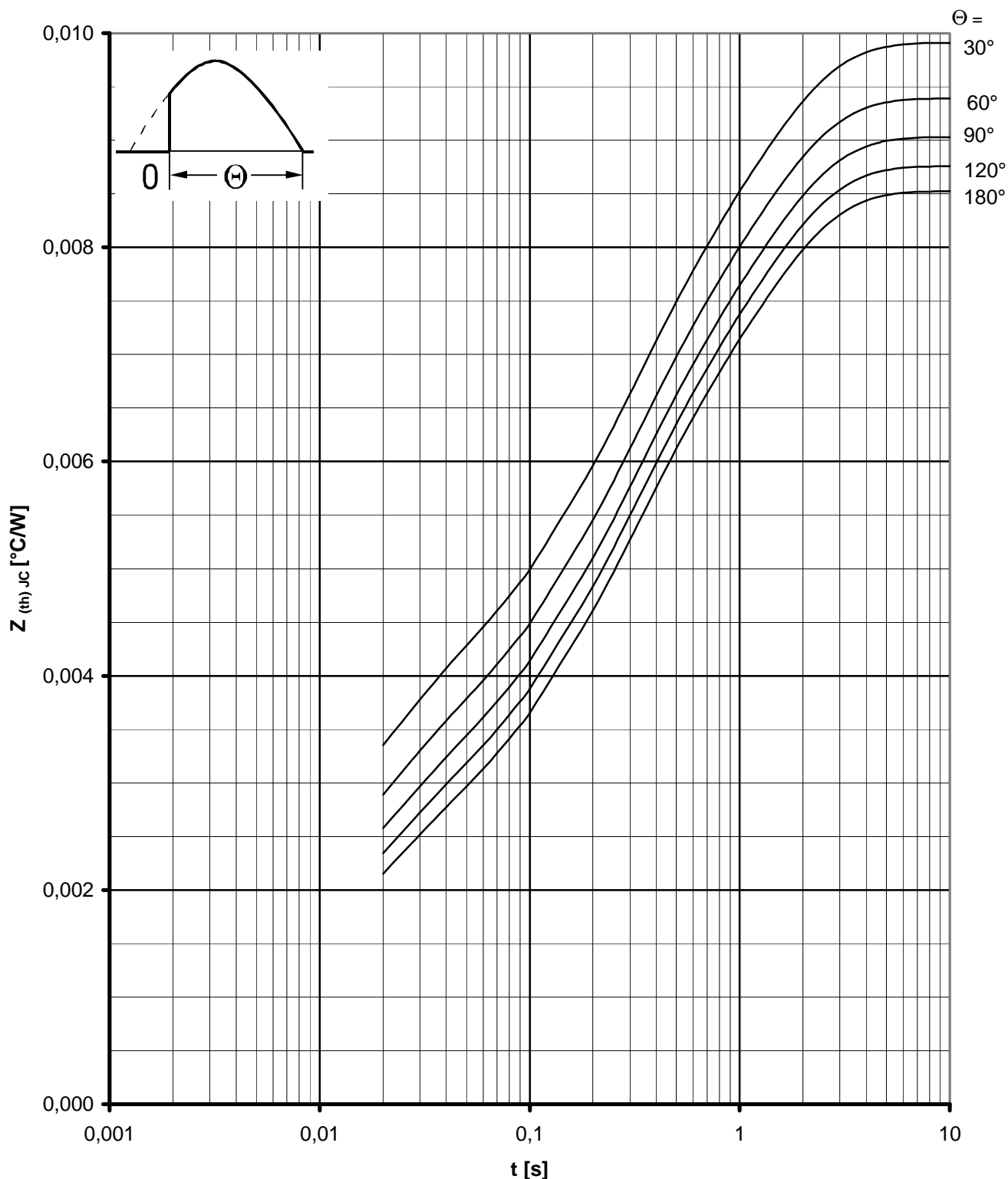

Transienter innerer Wärmewiderstand / Transient thermal impedance $Z_{(th)JC} = f(t)$
 Beidseitige Kühlung / Two-sided cooling
 Parameter: Stromflußwinkel Θ / current conduction angle Θ

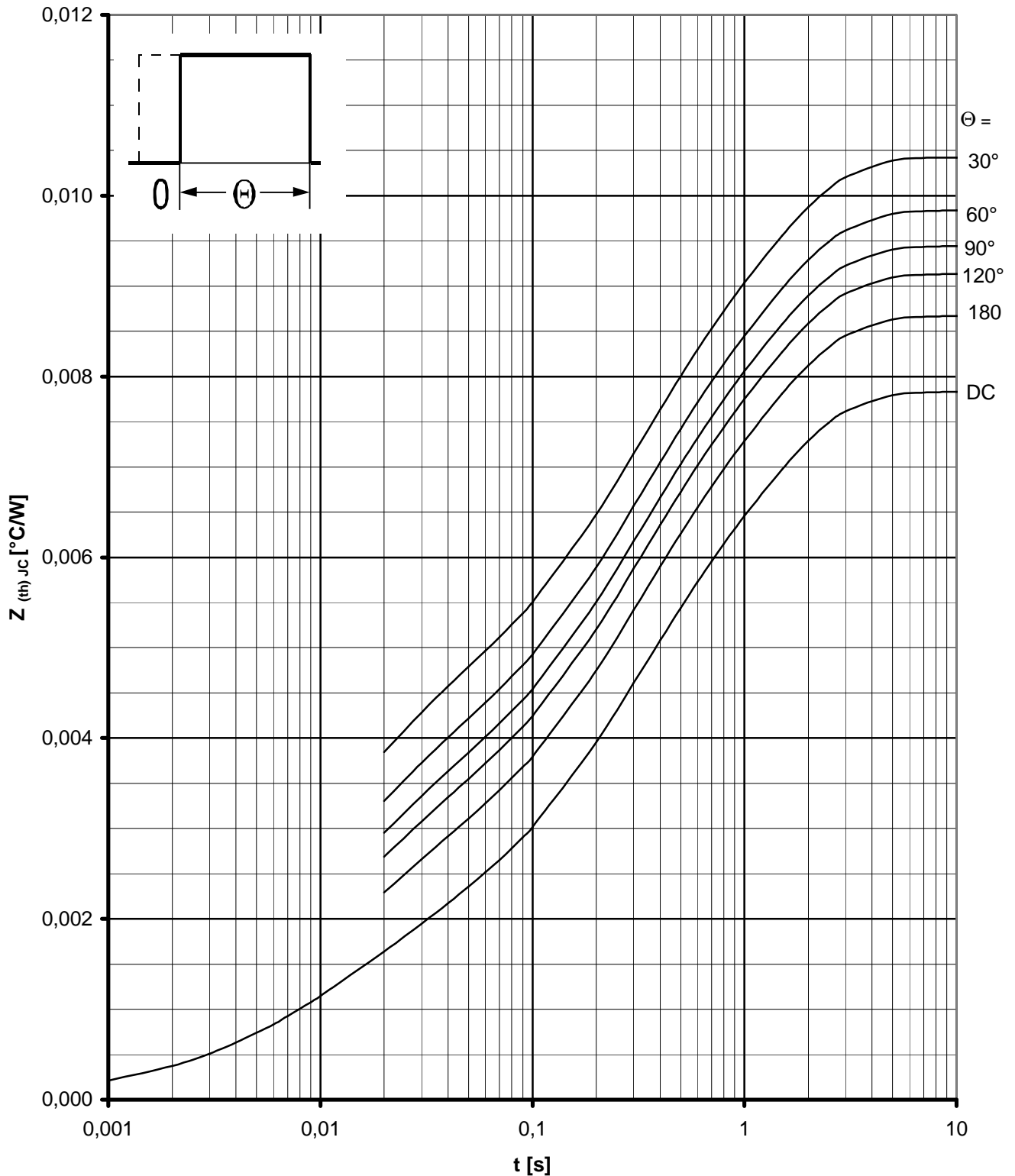

Transienter innerer Wärmewiderstand / Transient thermal impedance $Z_{(th)JC} = f(t)$
 Beidseitige Kühlung / Two-sided cooling
 Parameter: Stromflußwinkel Θ / current conduction angle Θ

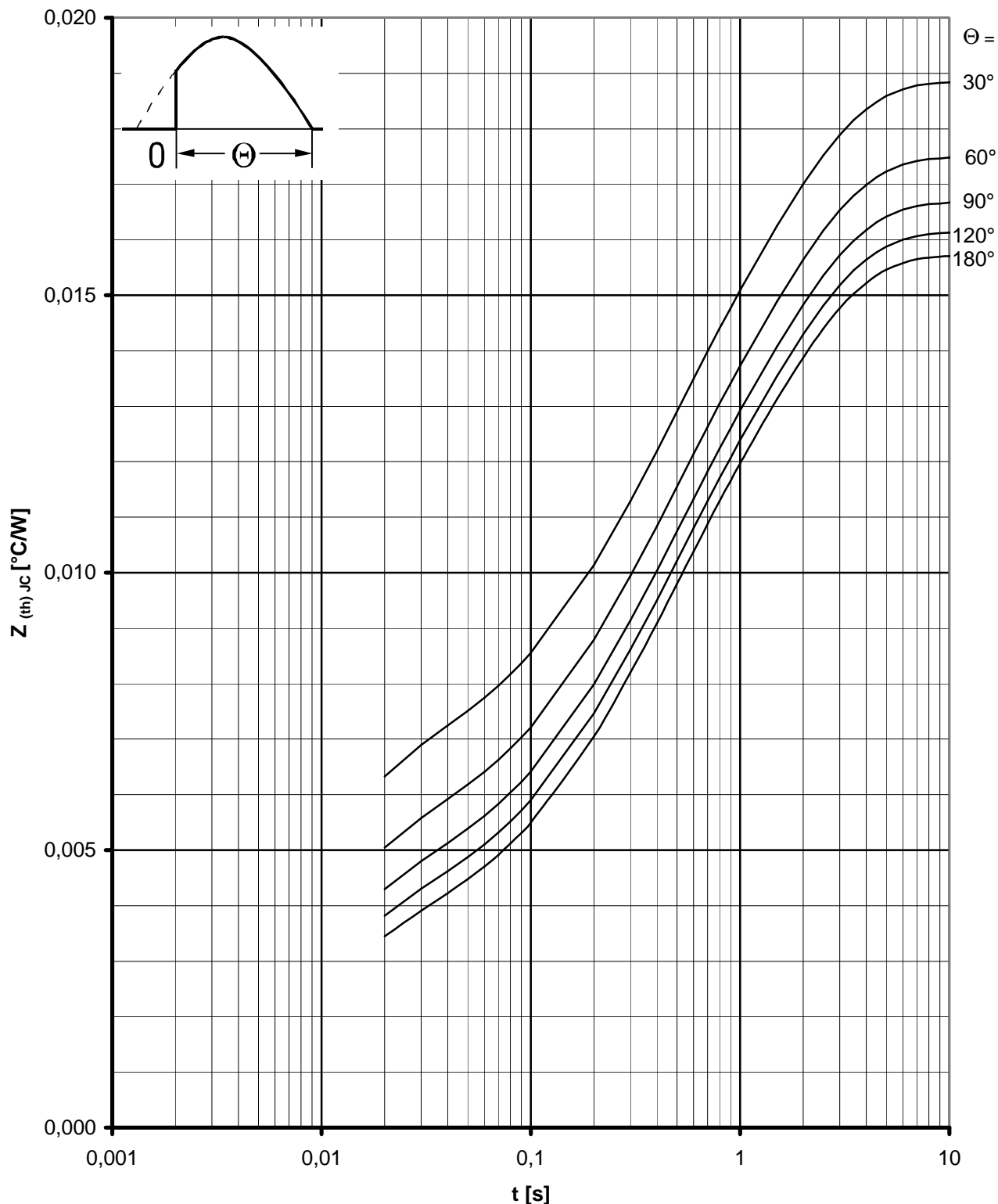

Transienter innerer Wärmewiderstand / Transient thermal impedance $Z_{(th)JC} = f(t)$
 Anodenseitige Kühlung / Anode-sided cooling
 Parameter: Stromflußwinkel Θ / current conduction angle Θ

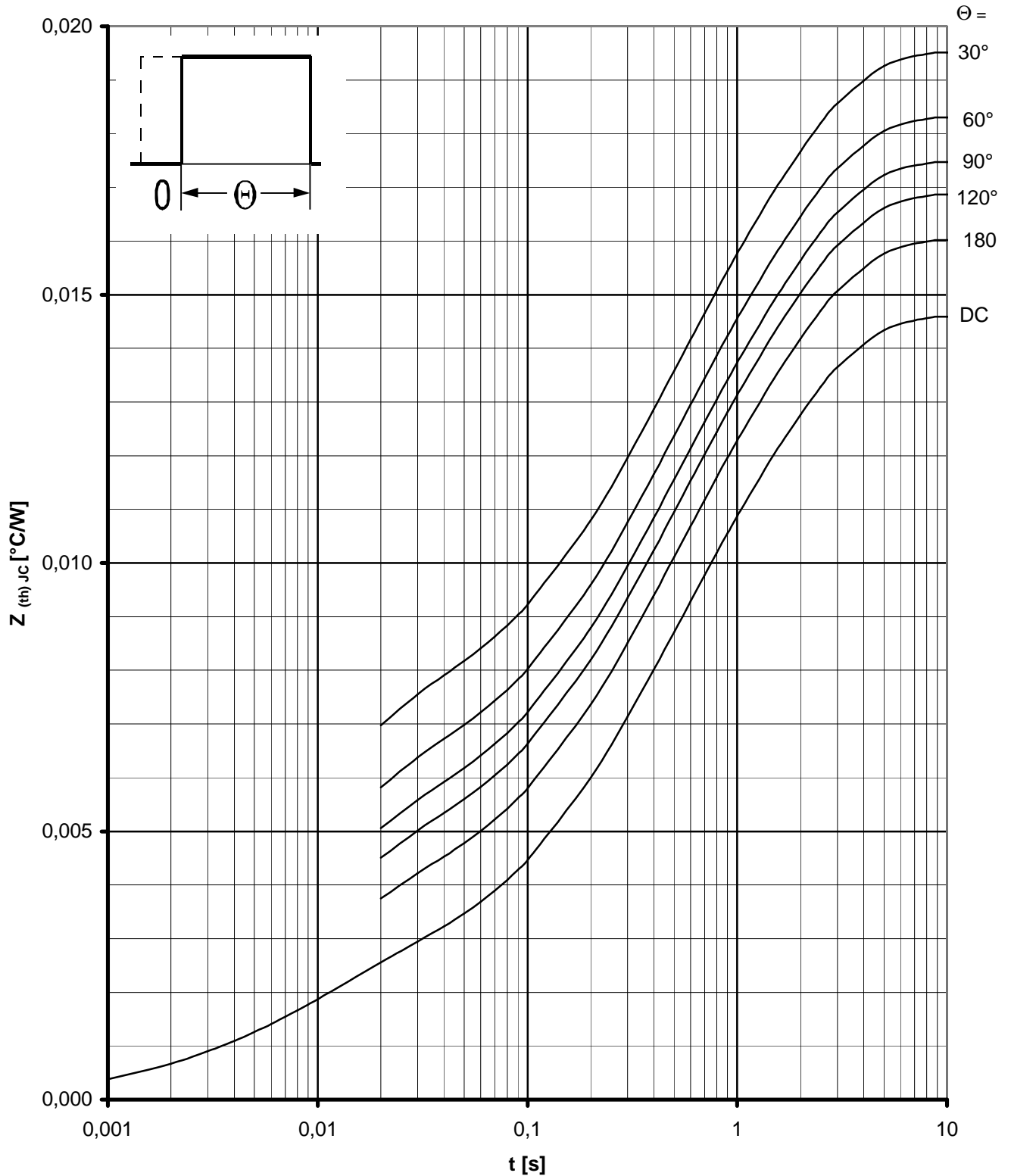

Transienter innerer Wärmewiderstand / Transient thermal impedance $Z_{(th)JC} = f(t)$

Anodenseitige Kühlung / Anode-sided cooling

Parameter: Stromflußwinkel Θ / current conduction angle Θ

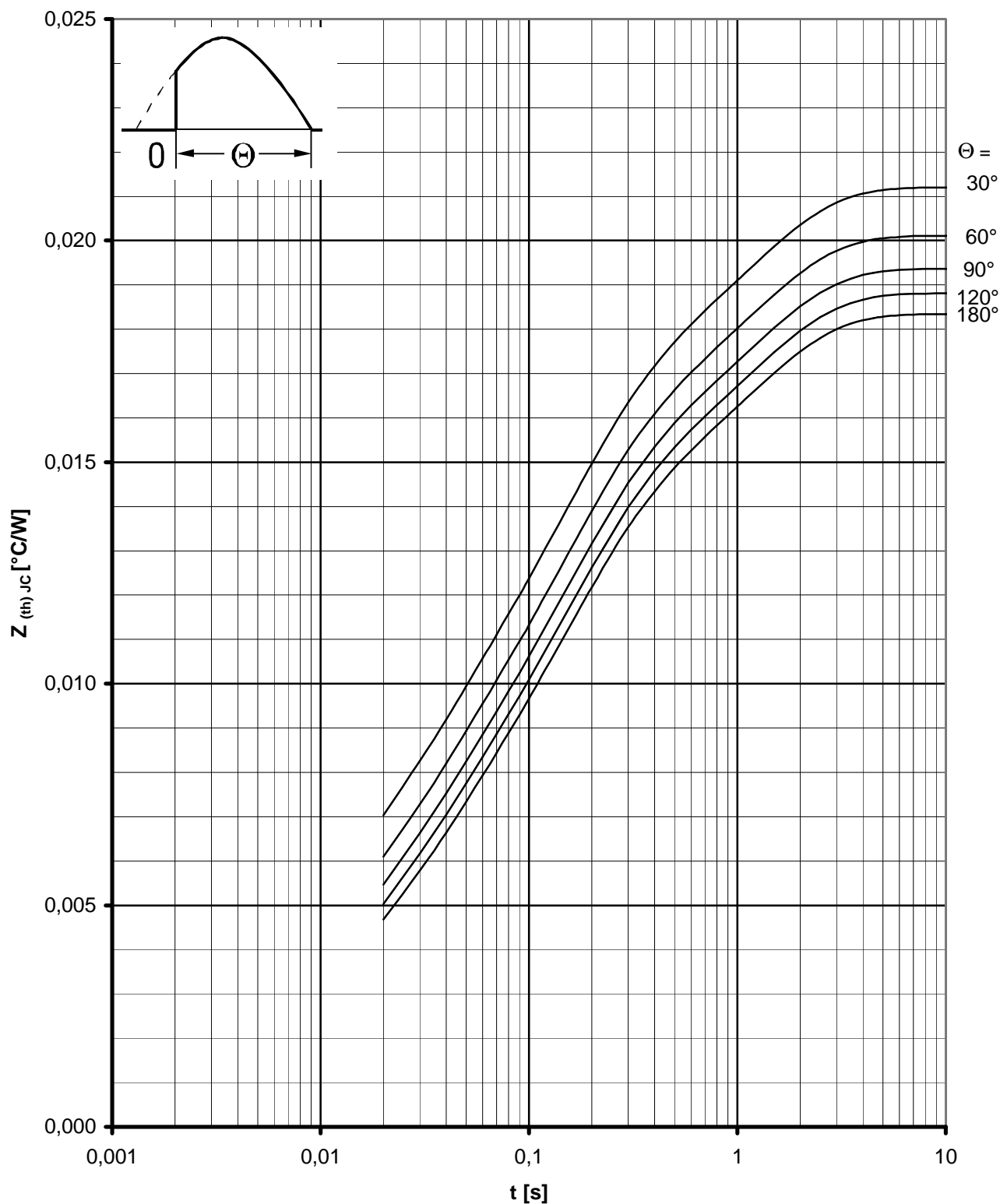

Transienter innerer Wärmewiderstand / Transient thermal impedance $Z_{(th),Jc} = f(t)$
 Kathodenseitige Kühlung / Cathode-sided cooling
 Parameter: Stromflußwinkel Θ / current conduction angle Θ

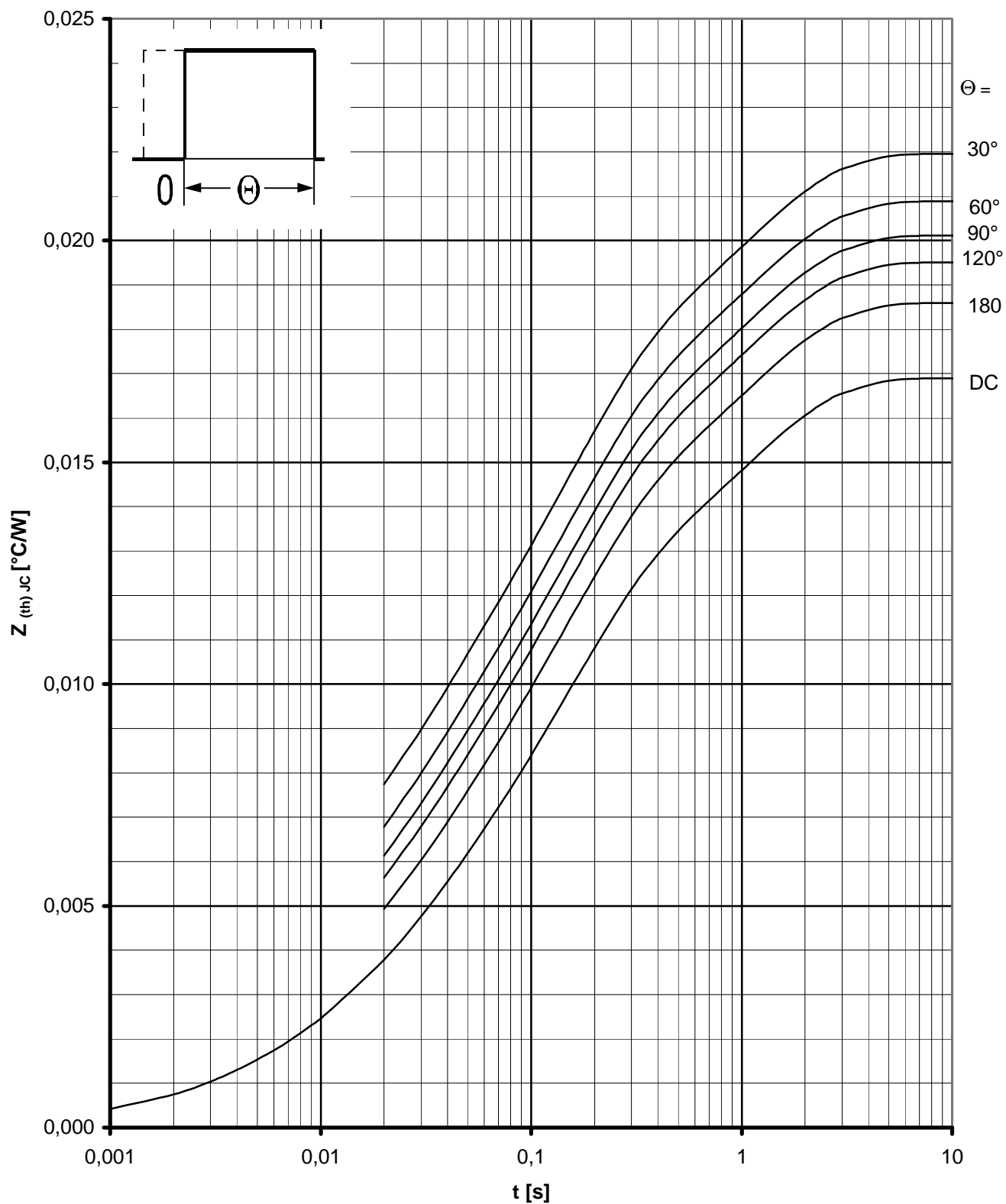

Transienter innerer Wärmewiderstand / Transient thermal impedance $Z_{(th)JC} = f(t)$
 Kathodenseitige Kühlung / Cathode-sided cooling
 Parameter: Stromflußwinkel Θ / current conduction angle Θ