



### Elektrische Eigenschaften / Electrical properties

Höchstzulässige Werte / Maximum rated values

Periodische Vorwärts- und Rückwärts-Spitzensperrspannung repetitive peak forward off-state and reverse voltages	$T_{vj} = -40^{\circ}\text{C} \dots T_{vj\text{ max}}$	$V_{\text{DRM}}, V_{\text{RRM}}$	1200 1600	1400 1800	V V <sup>1)</sup>
Vorwärts-Stoßspitzensperrspannung non-repetitive peak forward off-state voltage	$T_{vj} = -40^{\circ}\text{C} \dots T_{vj\text{ max}}$	$V_{\text{DSM}}$	1200 1600	1400 1800	V V
Rückwärts-Stoßspitzensperrspannung non-repetitive peak reverse voltage	$T_{vj} = +25^{\circ}\text{C} \dots T_{vj\text{ max}}$	$V_{\text{RSM}}$	1300 1700	1500 1900	V V
Durchlaßstrom-Grenzeffektivwert RMSM on-state current		$I_{\text{TRSMMSM}}$		800	A
Dauergrenzstrom average on-state current	$T_{\text{C}} = 85^{\circ}\text{C}$	$I_{\text{TAVM}}$		508	A
Stoßstrom-Grenzwert surge current	$T_{vj} = 25^{\circ}\text{C}, t_p = 10\text{ ms}$ $T_{vj} = T_{vj\text{ max}}, t_p = 10\text{ ms}$	$I_{\text{TSM}}$		8000 6900	A A
Grenzlastintegral $I^2t$ -value	$T_{vj} = 25^{\circ}\text{C}, t_p = 10\text{ ms}$ $T_{vj} = T_{vj\text{ max}}, t_p = 10\text{ ms}$	$I^2t$		320 238	$\text{A}^2\text{s} \cdot 10^3$ $\text{A}^2\text{s} \cdot 10^5$
Kritische Stromsteilheit critical rate of rise of on-state current	DIN IEC 747-6 $f=50\text{ Hz}, v_L = 10\text{ V}, i_{\text{GM}} = 1\text{ A}$ $di_{\text{G}}/dt = 1\text{ A}/\mu\text{s}$	$(di_{\text{T}}/dt)_{\text{cr}}$		120	$\text{A}/\mu\text{s}$
Kritische Spannungssteilheit critical rate of rise of off-state voltage	$T_{vj} = T_{vj\text{ max}}, v_{\text{D}} = 0,67 V_{\text{DRM}}$ 5.Kennbuchstabe / 5th letter F	$(dv_{\text{D}}/dt)_{\text{cr}}$		1000	$\text{V}/\mu\text{s}$

### Charakteristische Werte / Characteristic values

Durchlaßspannung on-state voltage	$T_{vj} = T_{vj\text{ max}}, i_{\text{T}} = 1600\text{ A}$	$v_{\text{T}}$	max.	1,92	V
Schleusenspannung threshold voltage	$T_{vj} = T_{vj\text{ max}}$	$V_{\text{T(TO)}}$		0,8	V
Ersatzwiderstand slope resistance	$T_{vj} = T_{vj\text{ max}}$	$r_{\text{T}}$		0,6	$\text{m}\Omega$
Durchlaßkennlinie on-state voltage $v_{\text{T}} = A + B \times i_{\text{T}} + C \times \ln(i_{\text{T}} + 1) + D \times \sqrt{i_{\text{T}}}$	$T_{vj} = T_{vj\text{ max}}$	A= 0,93854 B= 3,384E-04 C=-5,551E-02 D= 2,001E-02			
Zündstrom gate trigger current	$T_{vj} = 25^{\circ}\text{C}, v_{\text{D}} = 6\text{ V}$	$I_{\text{GT}}$	max.	200	mA
Zündspannung gate trigger voltage	$T_{vj} = 25^{\circ}\text{C}, v_{\text{D}} = 6\text{ V}$	$V_{\text{GT}}$	max.	2	V
Nicht zündener Steuerstrom gate non-trigger current	$T_{vj} = T_{vj\text{ max}}, v_{\text{D}} = 6\text{ V}$ $T_{vj} = T_{vj\text{ max}}, v_{\text{D}} = 0,5 V_{\text{DRM}}$	$I_{\text{GD}}$	max. max.	10 5	mA mA
Nicht zündene Steuerspannung gate non-trigger voltage	$T_{vj} = T_{vj\text{ max}}, v_{\text{D}} = 0,5 V_{\text{DRM}}$	$V_{\text{GD}}$	max.	0,2	mV
Haltestrom holding current	$T_{vj} = 25^{\circ}\text{C}, v_{\text{D}} = 6\text{ V}, R_{\text{A}} = 5\ \Omega$	$I_{\text{H}}$	max.	300	mA
Einraststrom latching current	$T_{vj} = 25^{\circ}\text{C}, v_{\text{D}} = 6\text{ V}, R_{\text{GK5}} = 10\ \Omega$ $i_{\text{GM}} = 1\text{ A}, di_{\text{G}}/dt = 1\text{ A}/\mu\text{s}$ $t_{\text{g}} = 20\ \mu\text{s}$	$I_{\text{L}}$	max.	1200	mA
Vorwärts- und Rückwärts-Sperrstrom forward off-state and reverse currents	$T_{vj} = T_{vj\text{ max}}$ $v_{\text{D}} = V_{\text{DRM}}, v_{\text{R}} = V_{\text{RRM}}$	$i_{\text{D}}, i_{\text{R}}$	max.	50	mA
Zündverzug gate controlled delay time	DIN IEC 747-6 $T_{vj} = 25^{\circ}\text{C}$ $i_{\text{GM}} = 1\text{ A}, di_{\text{G}}/dt = 1\text{ A}/\mu\text{s}$	$t_{\text{gd}}$	max.	4	$\mu\text{s}$

1) 1800 V auf Anfrage / 1800 V on demand

# Technische Information / Technical Information

**eupec**

Netz-Thyristor  
Phase Control Thyristor

## T 509 N 12 ...18

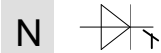

### Elektrische Eigenschaften / Electrical properties

Charakteristische Werte / Characteristic values

Freiwerdezeit circuit commutated turn-off time	$T_{vj} = T_{vj\ max}$ , $i_{TM} = I_{TAVM}$ $V_{RM} = 100V$ , $v_{DM} = 0,67 V_{DRM}$ $dv_D/dt = 20 V/\mu s$ , $-di_T/dt = 10 A/\mu s$ 4. Kennbuchstabe / 4th letter O	$t_q$	typ. 250	$\mu s$
---	--	-------	----------	---------

### Thermische Eigenschaften / Thermal properties

Innerer Wärmewiderstand thermal resistance, junction to case	Kühlfläche / cooling surface beidseitig / two-sided, $\varphi = 180^\circ \sin$ beidseitig / two-sided, DC Anode / anode, $\varphi = 180^\circ \sin$ Anode / anode, DC Kathode / cathode, $\varphi = 180^\circ \sin$ Kathode / cathode, DC	$R_{thJC}$	max. 0,0530 max. 0,0500 max. 0,0880 max. 0,0850 max. 0,1230 max. 0,1200	$^\circ C/W$ $^\circ C/W$ $^\circ C/W$ $^\circ C/W$ $^\circ C/W$ $^\circ C/W$
Übergangs- Wärmewiderstand thermal resistance, case to heatsink	Kühlfläche / cooling surface beidseitig / two-sided einseitig / single-sided	$R_{thCK}$	max. 0,0075 max. 0,0150	$^\circ C/W$ $^\circ C/W$
Höchstzulässige Sperrschichttemperatur max. junction temperature		$T_{vj\ max}$	125	$^\circ C$
Betriebstemperatur operating temperature		$T_{c\ op}$	-40...125	$^\circ C$
Lagertemperatur storage temperature		$T_{stg}$	-40...140	$^\circ C$

### Mechanische Eigenschaften / Mechanical properties

Gehäuse, siehe Anlage case, see appendix			Seite 3 page 3	
Si-Element mit Druckkontakt Si-pellet with pressure contact				
Anpreßkraft clamping force		F	5 ...10	kN
Gewicht weight		G	typ. 270	g
Kriechstrecke creepage distance			28	mm
Feuchteklasse humidity classification	DIN 40040		C	
Schwingfestigkeit vibration resistance	f = 50Hz		50	m/s <sup>2</sup>

Mit dieser technischen Information werden Halbleiterbauelemente spezifiziert, jedoch keine Eigenschaften zugesichert. Sie gilt in Verbindung mit den zugehörigen Technischen Erläuterungen./ The technical information specifies semiconductor devices but promises no characteristics. It is valid in combination with the belonging technical notes.

Netz-Thyristor  
Phase Control Thyristor

T 509 N 12 ...18

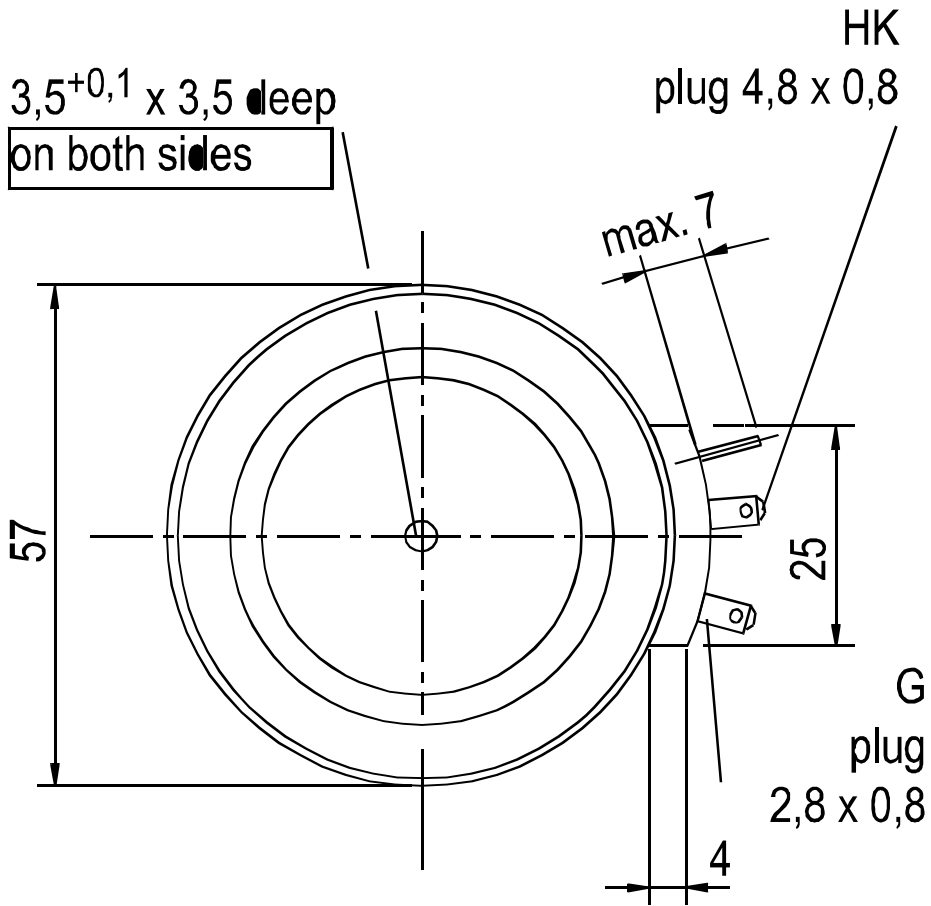
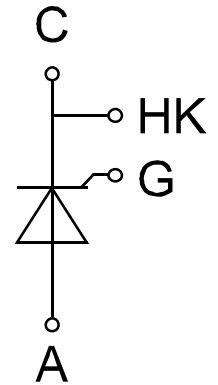
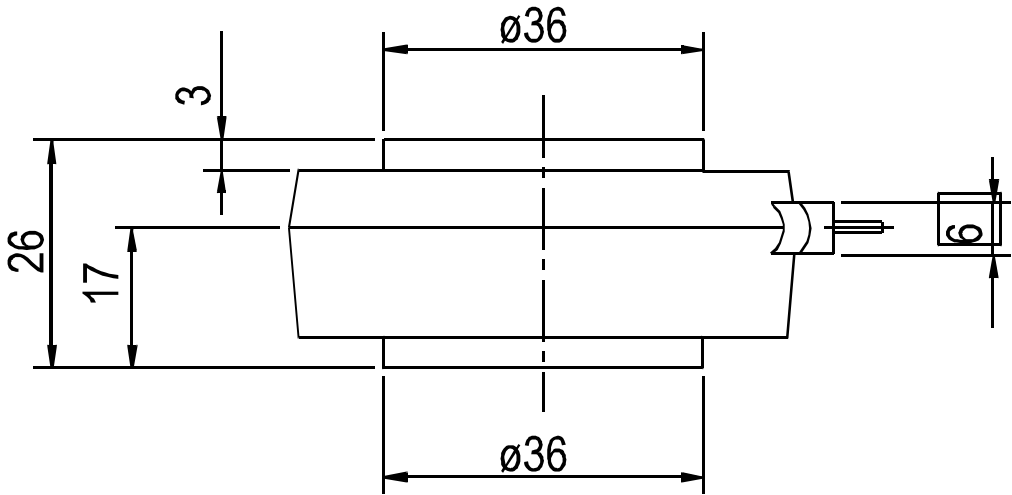

Kühlung cooling	Analytische Elemente des transienten Wärmewiderstandes $Z_{thJC}$ für DC Analytical elements of transient thermal impedance $Z_{thJC}$ for DC							
	Pos.n	1	2	3	4	5	6	7
beidseitig two-sided	$R_{thn}$ [°C/W]	0,010500	0,002830	0,016700	0,018800	0,001160		
	$\tau_n$ [s]	0,001130	0,025500	0,051100	0,429000	2,490000		
anodenseitig anode-sided	$R_{thn}$ [°C/W]	0,009400	0,009740	0,018200	0,016100	0,031600		
	$\tau_n$ [s]	0,000984	0,016700	0,204000	0,821000	5,000000		
kathodenseitig cathode-sided	$R_{thn}$ [°C/W]	0,009280	0,014500	0,008680	0,040100	0,047500		
	$\tau_n$ [s]	0,000939	0,028500	0,156000	1,120000	9,100000		
Analytische Funktion / analytical function : $Z_{thJC} = \sum_{n=1}^{n_{max}} R_{thn} ( 1 - EXP ( - t / \tau_n ) )$								

Netz-Thyristor  
Phase Control Thyristor

T 509 N 12 ...18

N

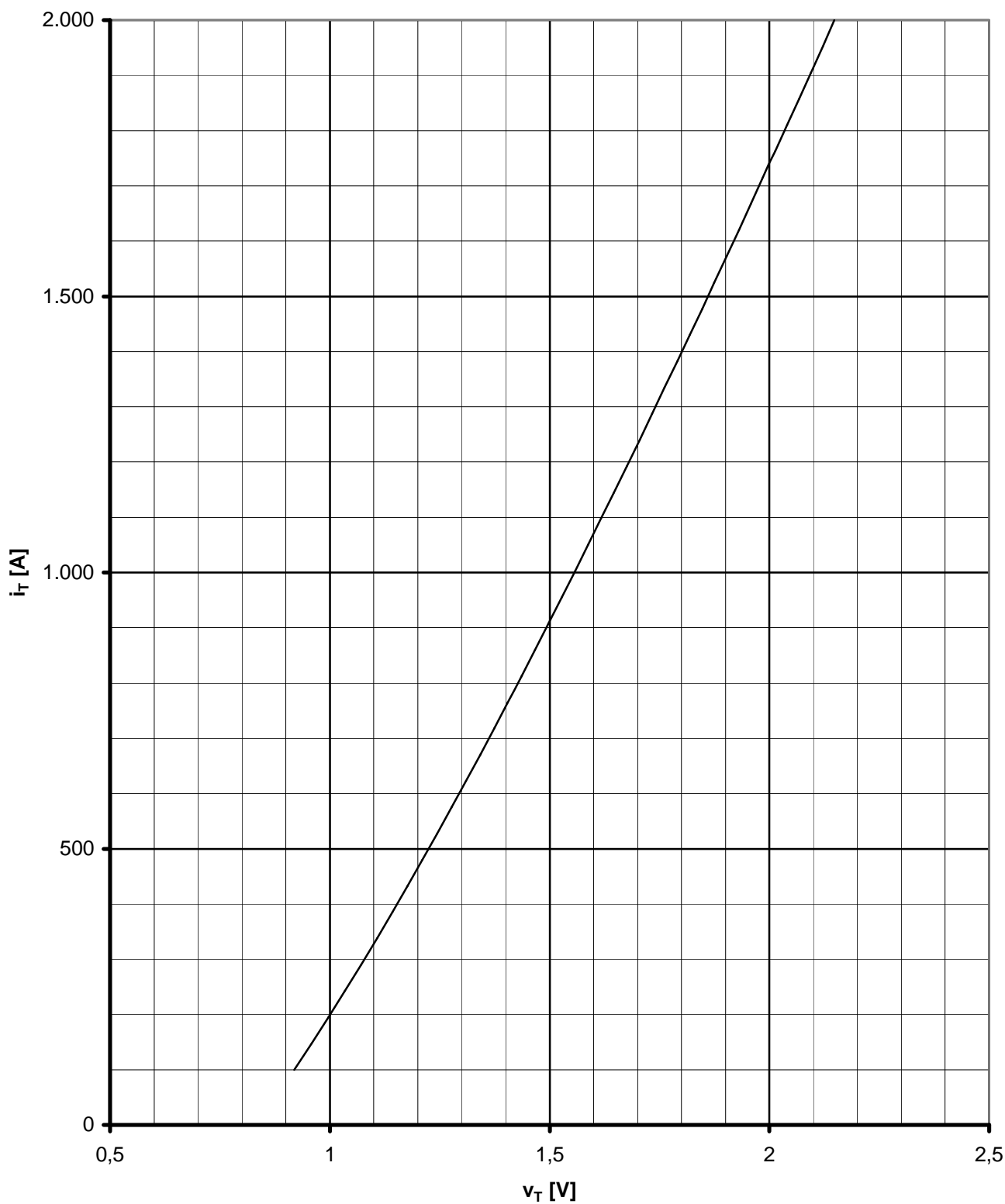

Grenzdurchlaßkennlinie / Limiting On-state characteristics  $i_T = f(v_T)$   
 $T_{vj} = T_{vj} \text{ max}$

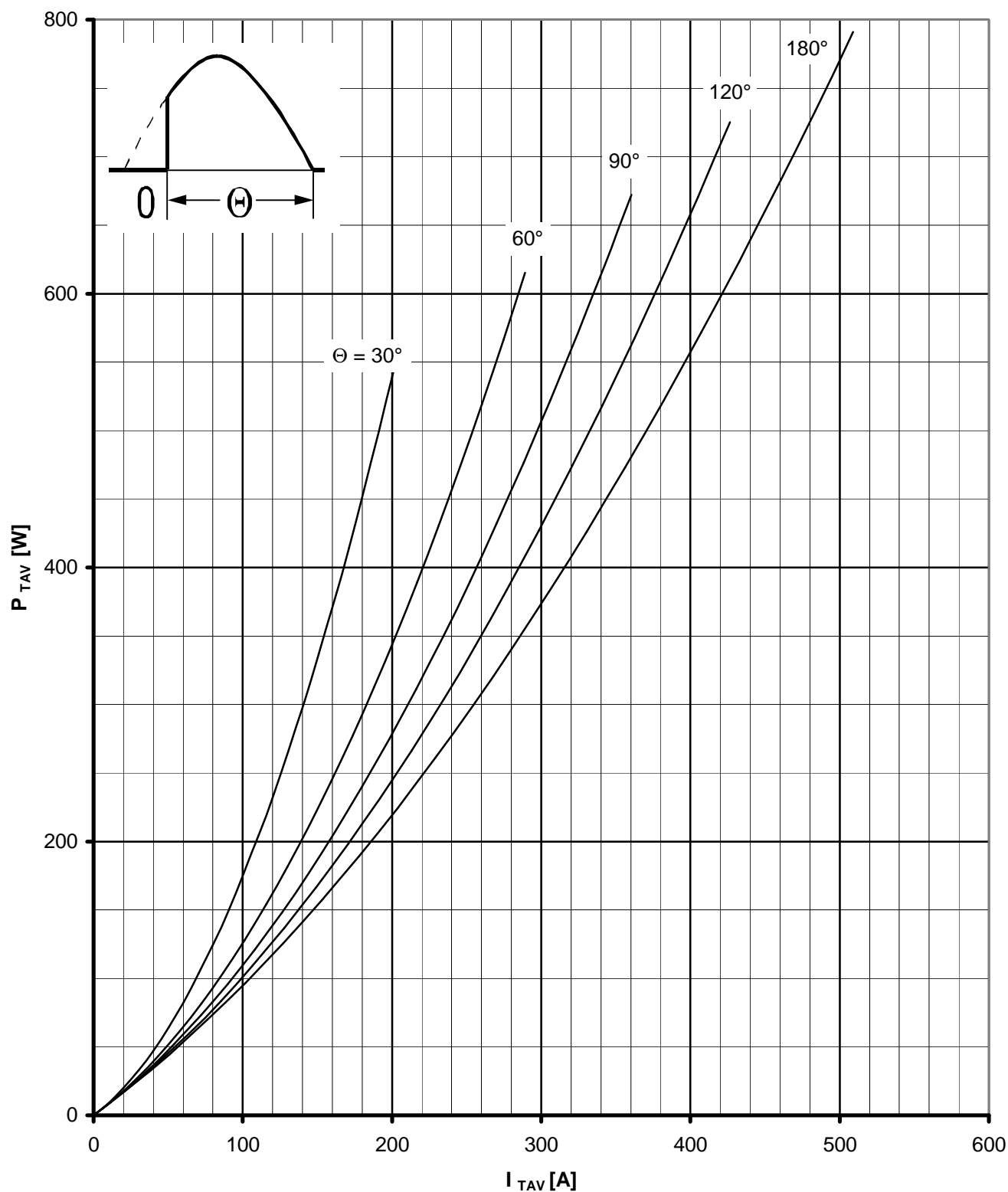

Durchlaßverlustleistung / On-state power loss  $P_{TAV} = f(I_{TAV})$   
 Parameter: Stromflußwinkel  $\theta$  / current conduction angle  $\theta$

Netz-Thyristor  
Phase Control Thyristor

T 509 N 12 ...18

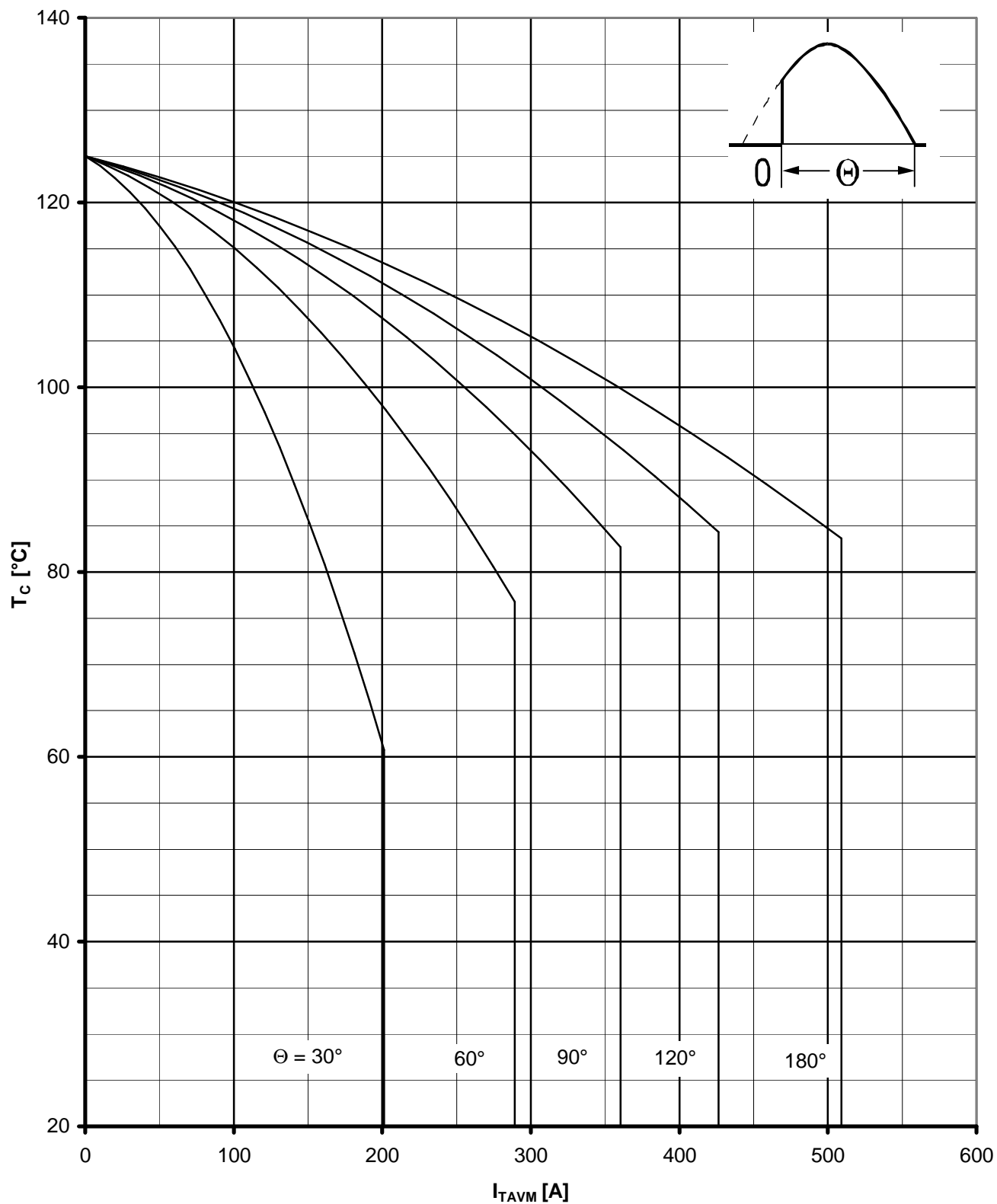
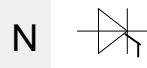

Höchstzulässige Gehäusetemperatur / Maximum allowable case temperature  $T_C = f(I_{TAVM})$

Beidseitige Kühlung / Two-sided cooling

Parameter: Stromflußwinkel  $\Theta$  / current conduction angle  $\Theta$

Netz-Thyristor  
Phase Control Thyristor

T 509 N 12 ...18

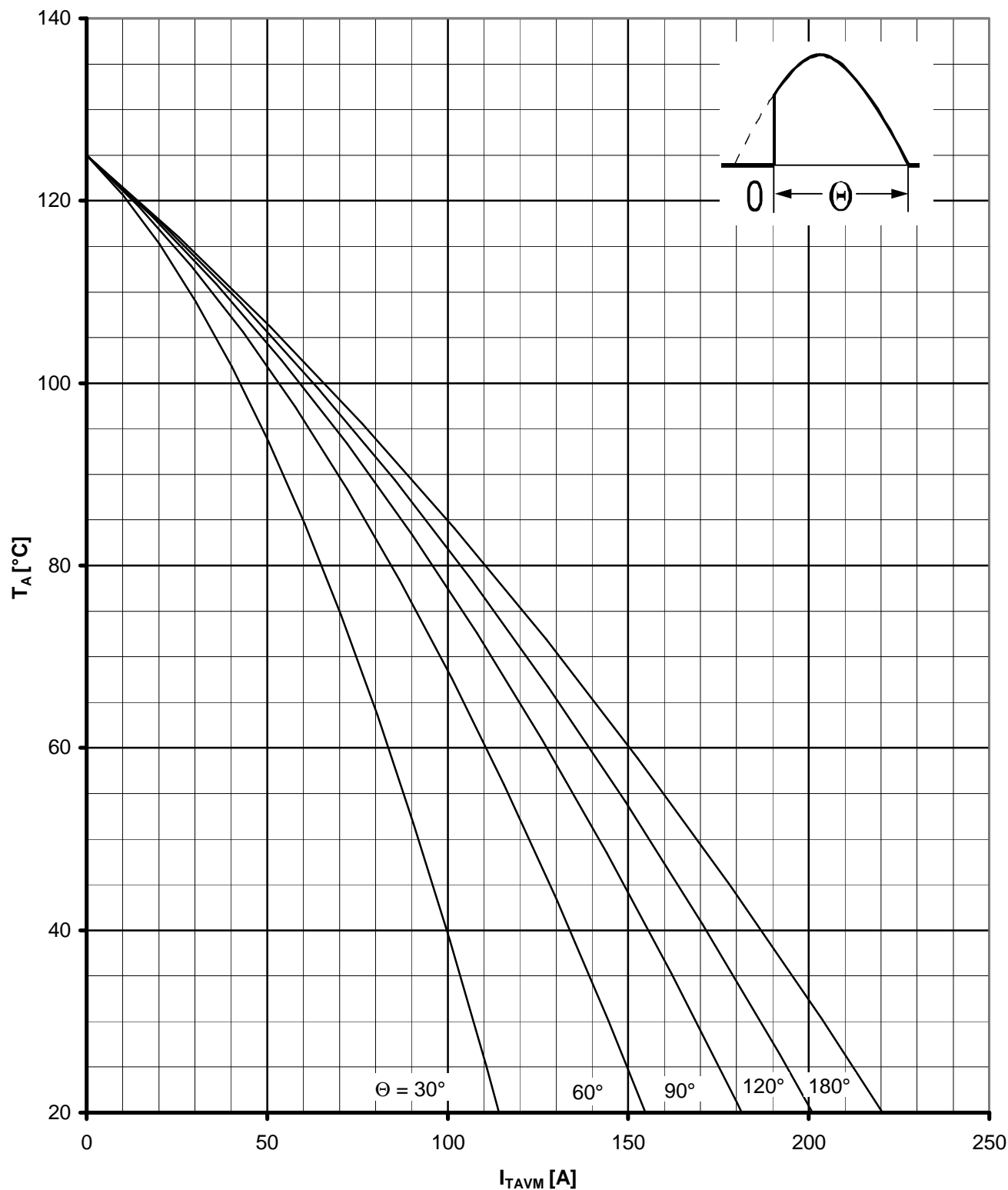

Höchstzulässige Kühlmitteltemperatur / Max. allowable cooling medium temperature  $T_A = f(I_{TAVM})$

Luftselbstkühlung / Natural air-cooling

Kühlkörper/Heatsink. K0.36S

Parameter: Stromflußwinkel  $\Theta$  / current conduction angle  $\Theta$



Netz-Thyristor  
Phase Control Thyristor

T 509 N 12 ...18

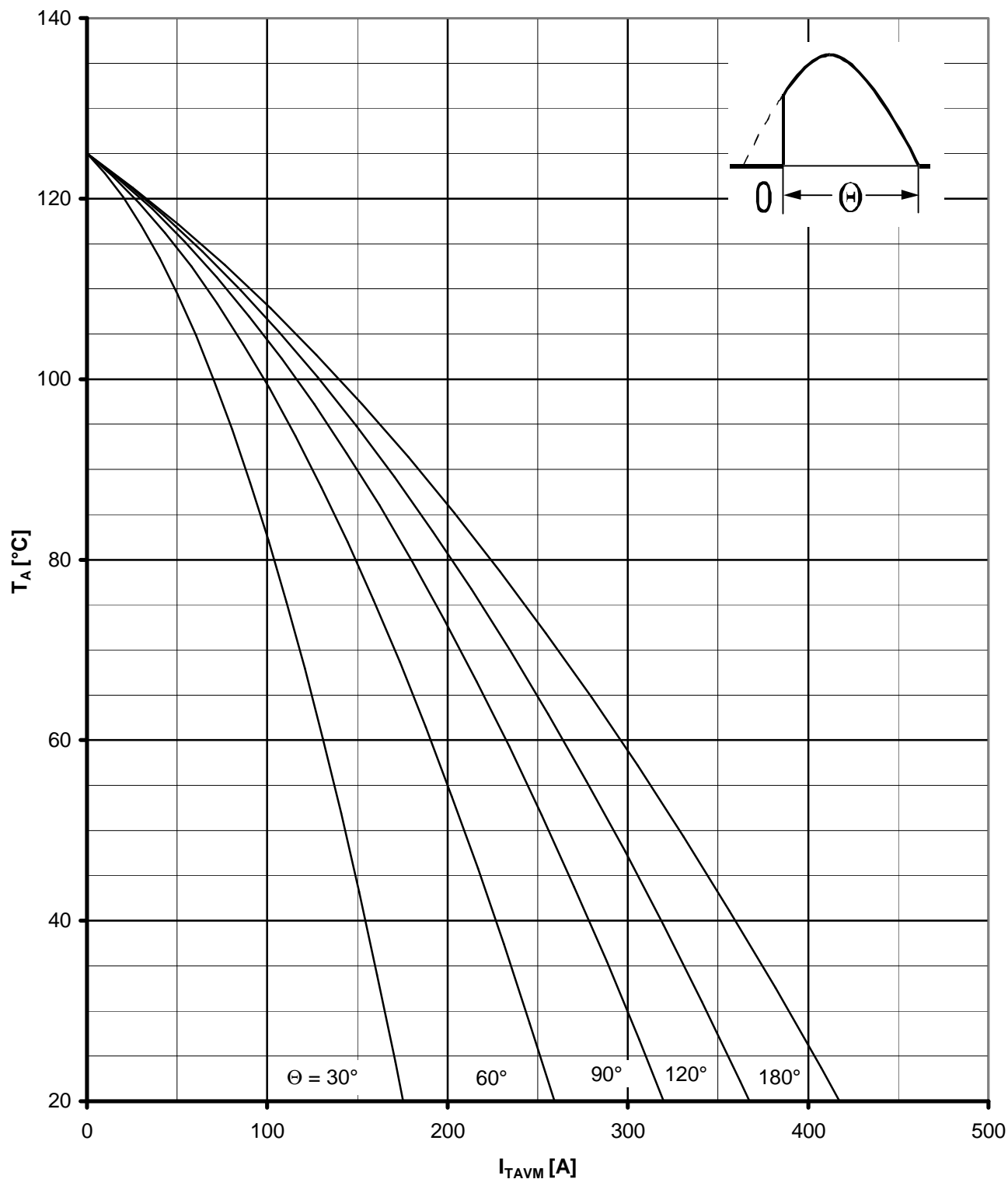
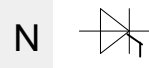

Höchstzulässige Kühlmitteltemperatur / Max. allowable cooling medium temperature  $T_A = f(I_{TAVM})$

Verstärkte Luftkühlung / Forced air-cooling

Kühlkörper/Heatsink. K0.05F,  $V_L = 50$  l/s

Parameter: Stromflußwinkel  $\theta$  / current conduction angle  $\theta$

Netz-Thyristor  
Phase Control Thyristor

T 509 N 12 ...18

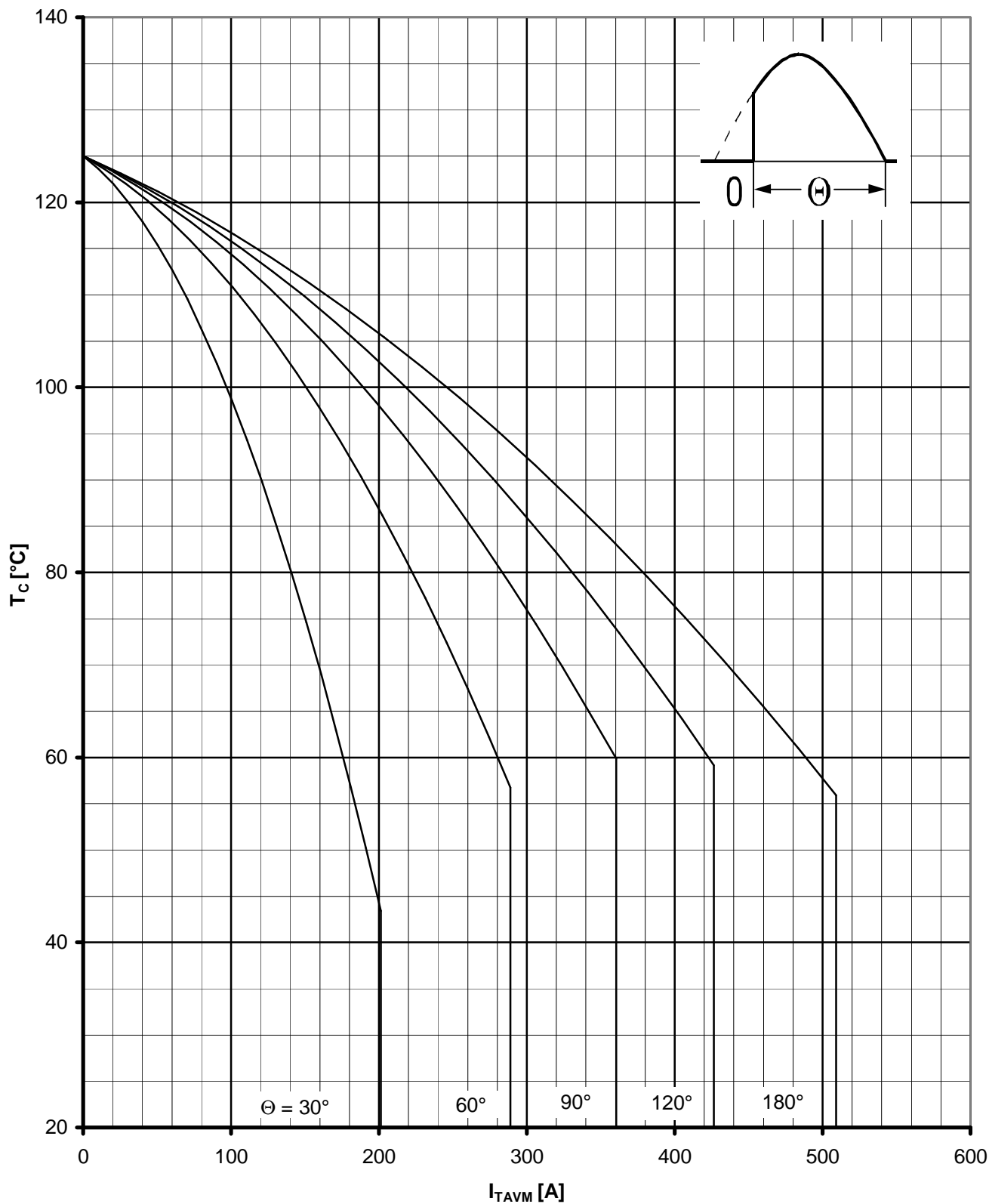
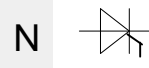

Höchstzulässige Gehäusetemperatur / Maximum allowable case temperature  $T_c = f(I_{TAVM})$

Anodenseitige Kühlung / anode sided cooling

Parameter: Stromflußwinkel  $\theta$  / current conduction angle  $\theta$

Netz-Thyristor  
Phase Control Thyristor

T 509 N 12 ...18

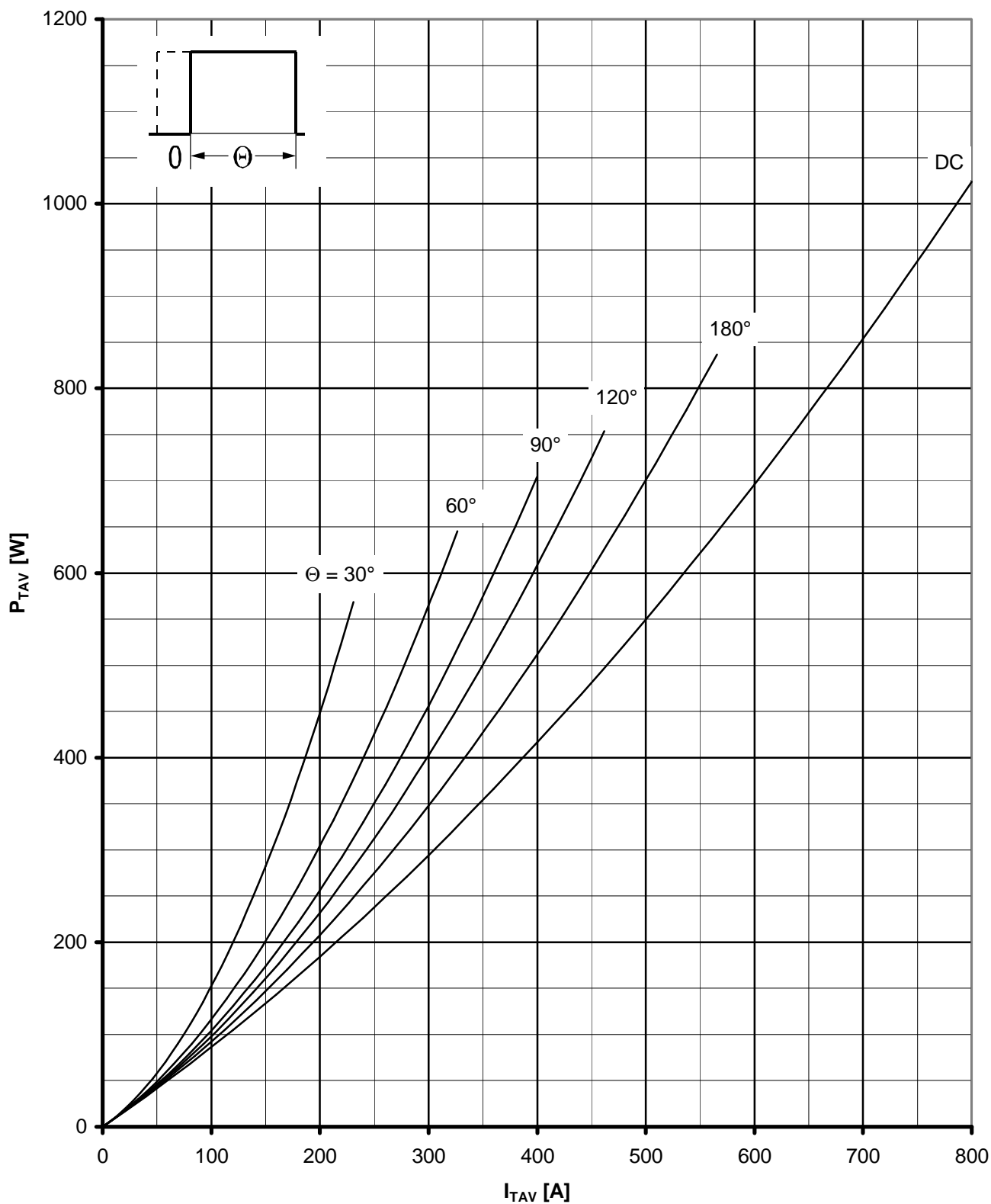

Durchlaßverlustleistung / On-state power loss  $P_{TAV} = f(I_{TAV})$   
Parameter: Stromflußwinkel  $\theta$  / current conduction angle  $\theta$

Netz-Thyristor  
Phase Control Thyristor

T 509 N 12 ...18

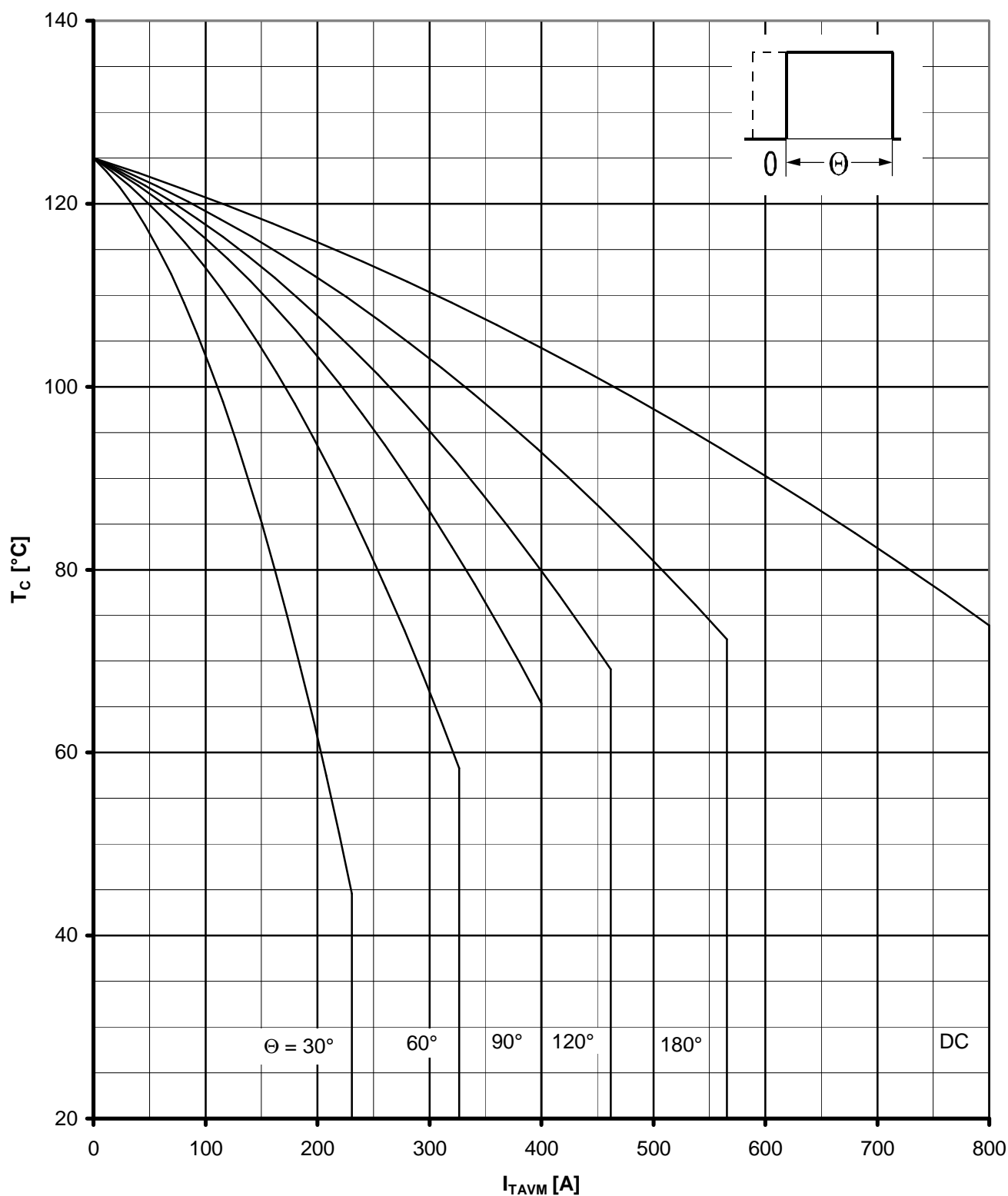

Höchstzulässige Gehäusetemperatur / Maximum allowable case temperature  $T_C = f(I_{TAVM})$

Beidseitige Kühlung / Two-sided cooling

Parameter: Stromflußwinkel  $\theta$  / current conduction angle  $\theta$

Netz-Thyristor  
Phase Control Thyristor

T 509 N 12 ...18

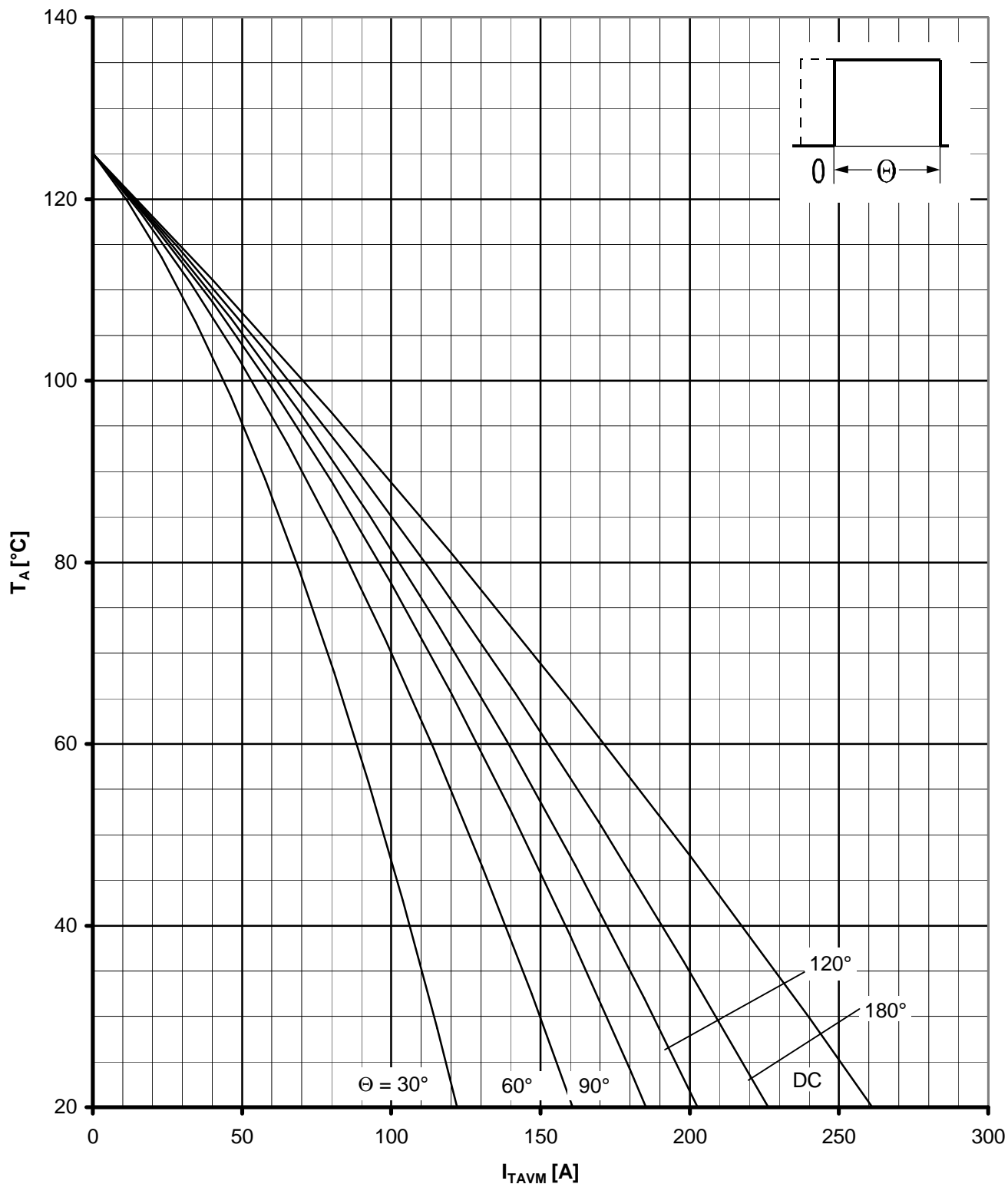
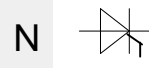

Höchstzulässige Kühlmitteltemperatur / Max. allowable cooling medium temperature  $T_A = f(I_{TAVM})$   
 Luftselbstkühlung / Natural air-cooling  
 Kühlkörper/Heatsink. K 0.36 S  
 Parameter: Stromflußwinkel  $\Theta$  / current conduction angle  $\Theta$

Netz-Thyristor  
Phase Control Thyristor

T 509 N 12 ...18

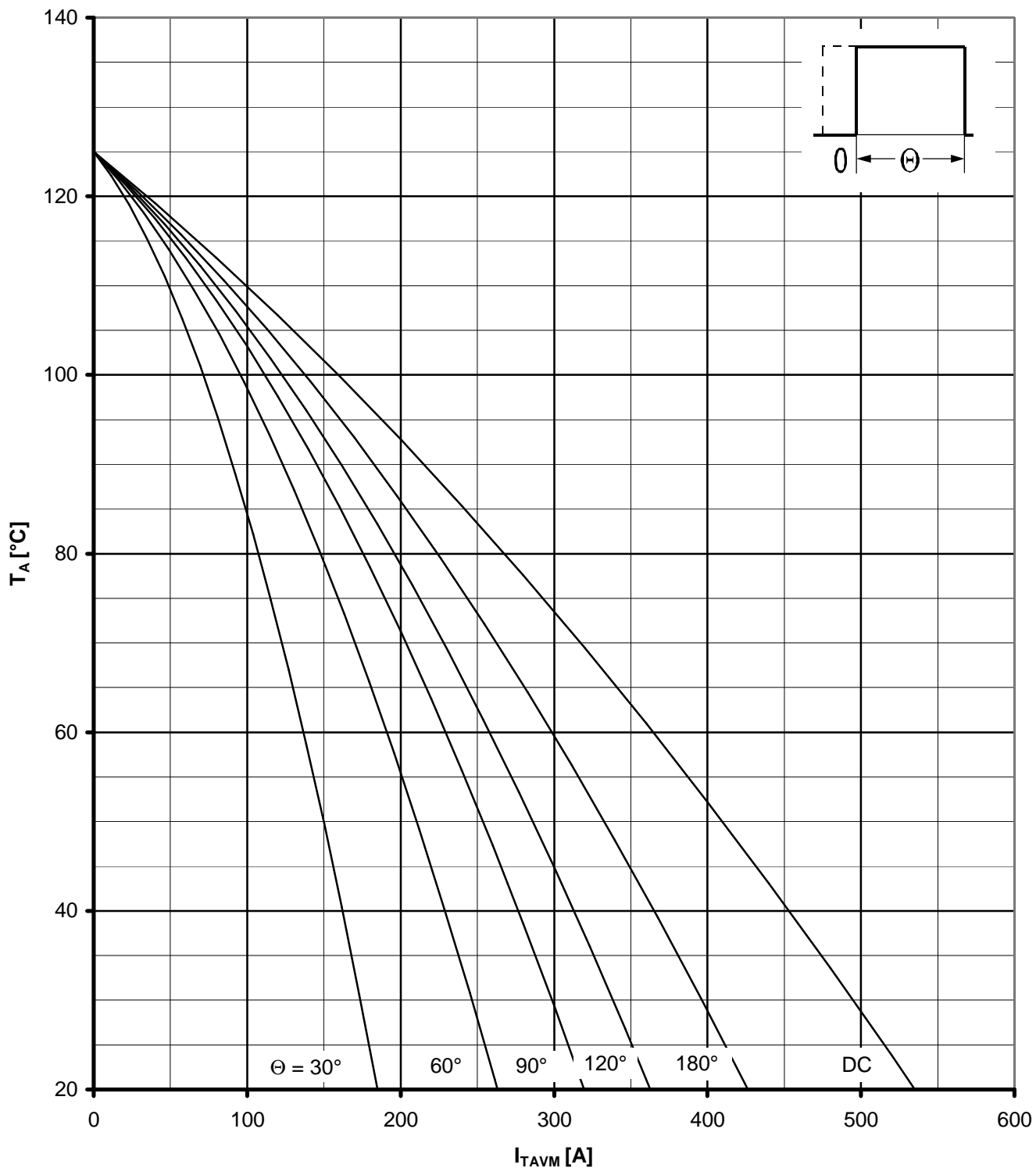
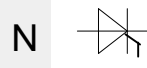

Höchstzulässige Kühlmitteltemperatur / Max. allowable cooling medium temperature  $T_A = f(I_{TAVM})$

Verstärkte Luftkühlung / Forced air-cooling

Kühlkörper/Heatsink. K0.05F,  $V_L = 50$  l/s

Parameter: Stromflußwinkel  $\theta$  / current conduction angle  $\theta$

Netz-Thyristor  
Phase Control Thyristor

T 509 N 12 ...18

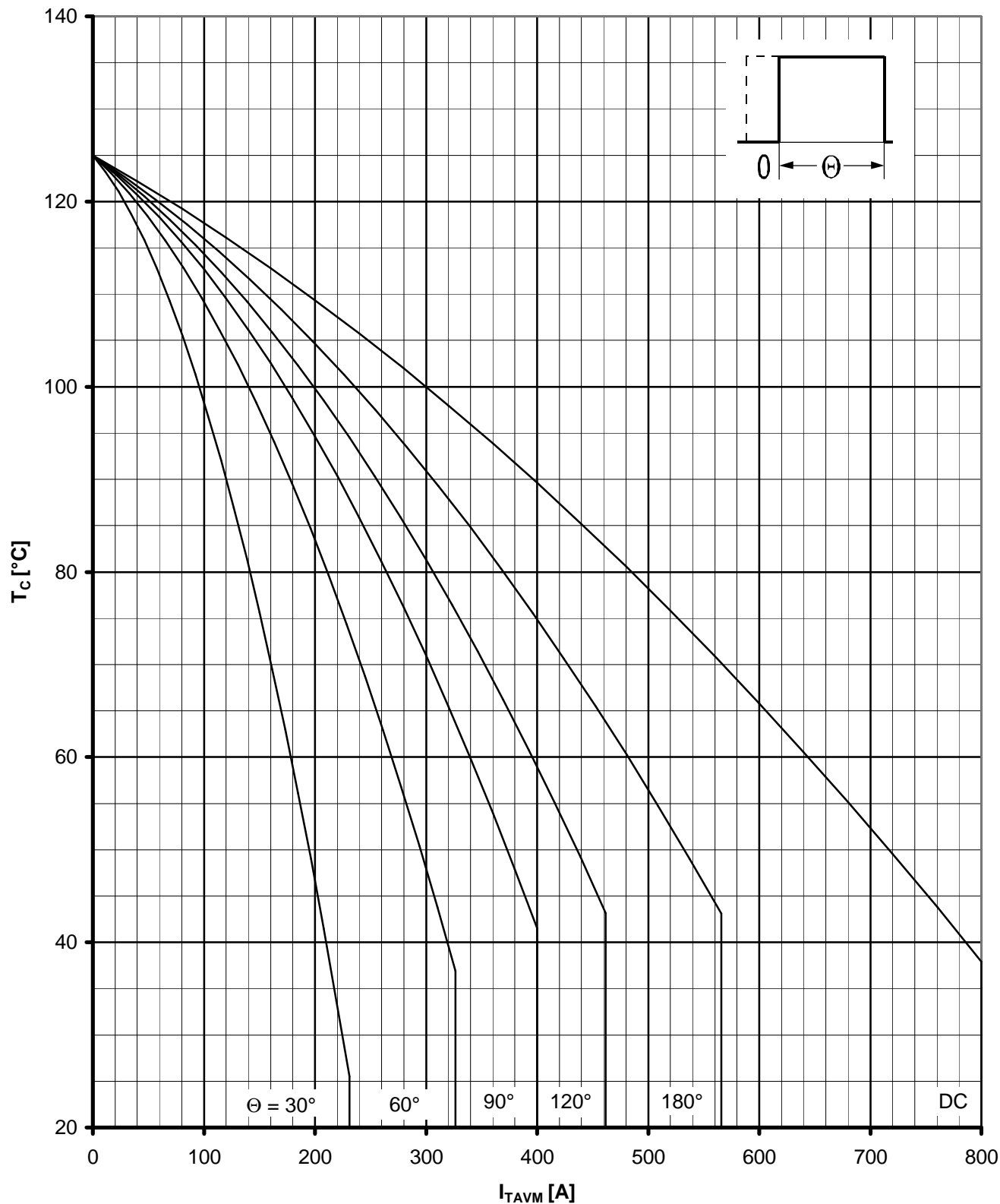
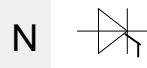

Höchstzulässige Gehäusetemperatur / Maximum allowable case temperature  $T_c = f(I_{TAVM})$

Anodenseitige Kühlung / anode sided cooling

Parameter: Stromflußwinkel  $\theta$  / current conduction angle  $\theta$

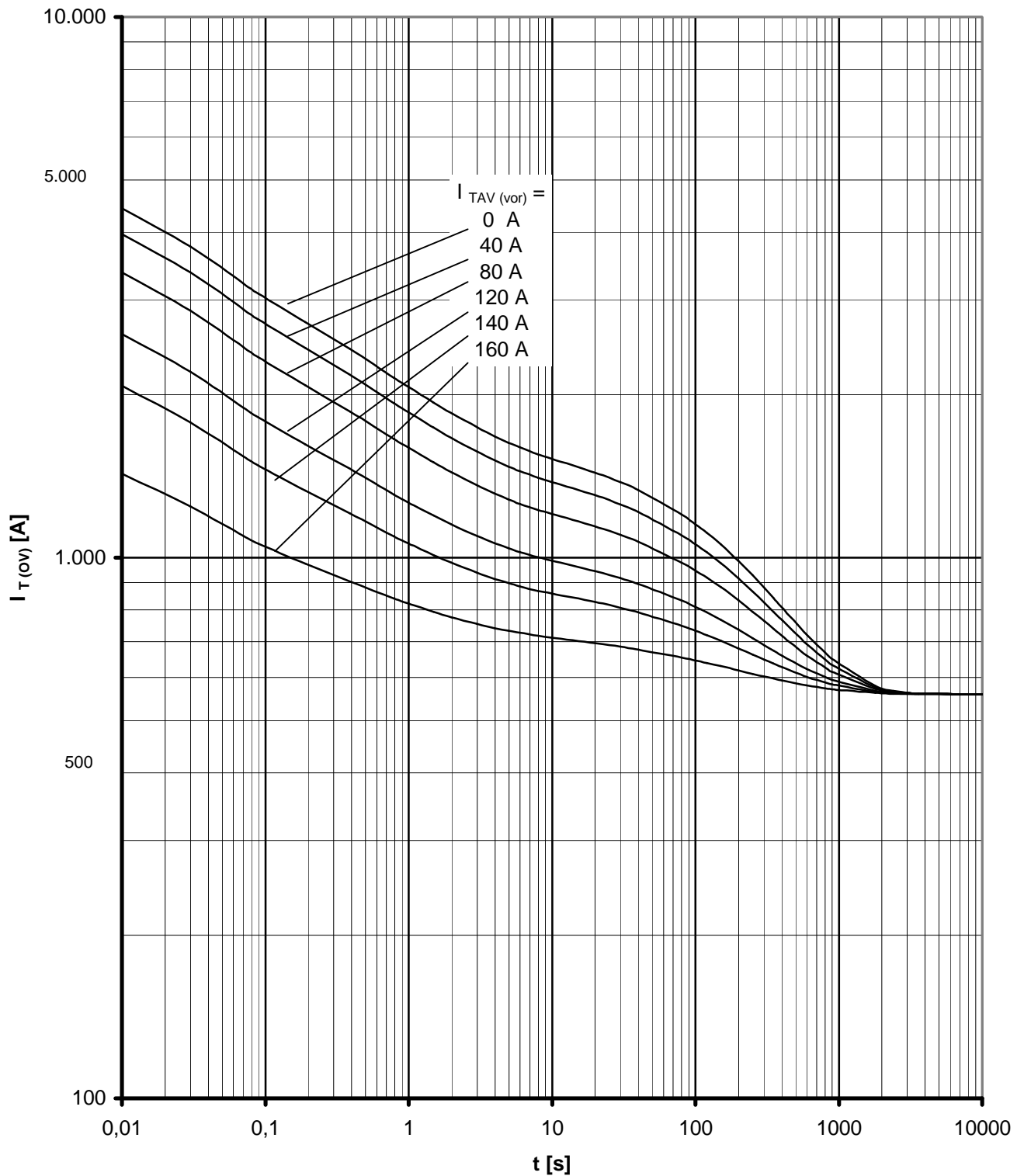

Überstrom / Overload on-state current  $I_{T(OV)} = f(t)$

Beidseitige Luftselbstkühlung / Two-sided natural cooling K 0.36 S

$T_A = 45^\circ\text{C}$

Parameter: Vorlaststrom / pre-load current  $I_{TAV(vor)}$



Netz-Thyristor  
Phase Control Thyristor

T 509 N 12 ...18

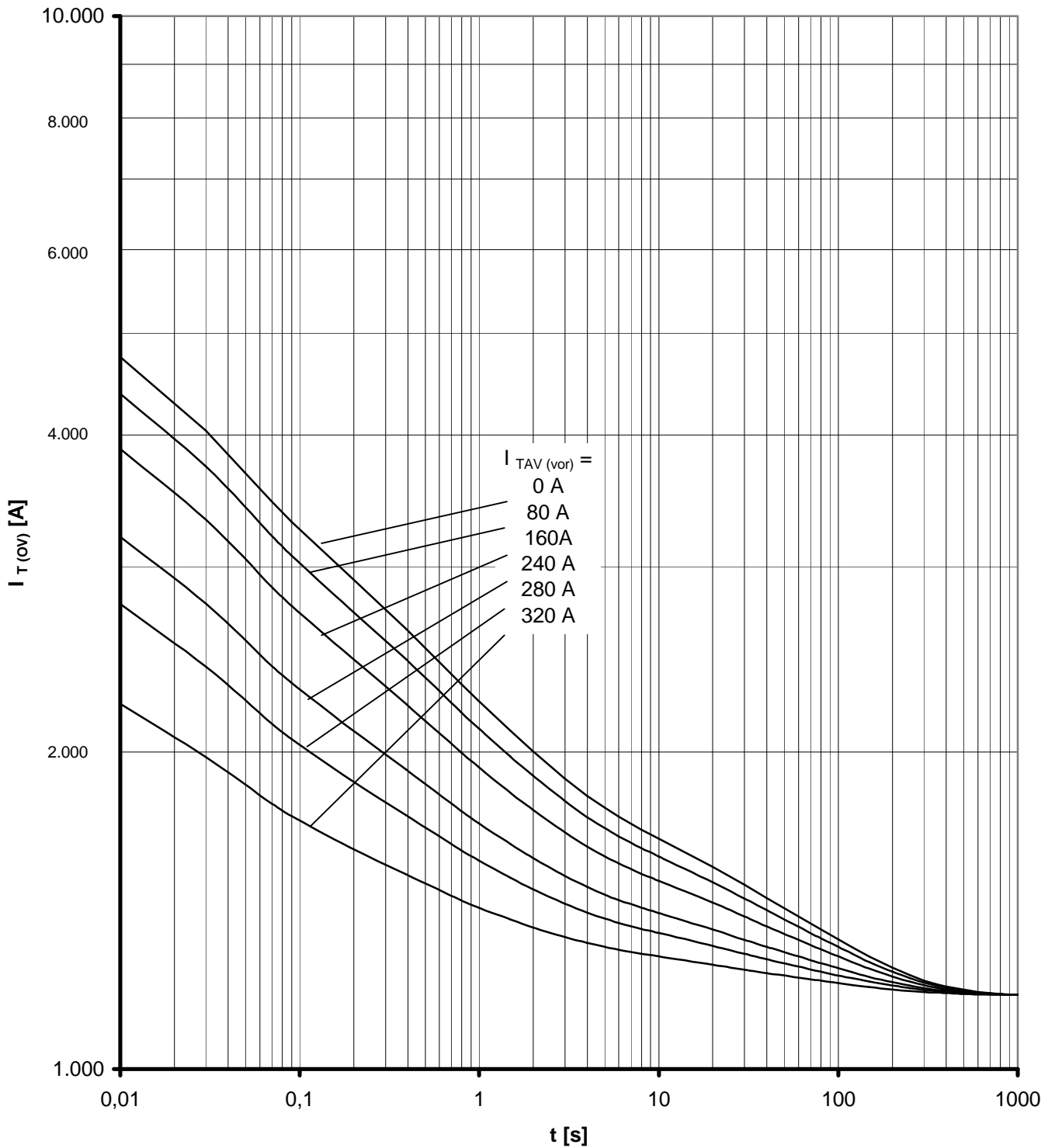

Überstrom / Overload on-state current  $I_{T(OV)} = f(t)$

Beidseitige verstärkte Kühlung / forced two-sided cooling K0.12F

$T_A = 35^\circ\text{C}$ ,  $V_L = 50$  l/s

Parameter: Vorlaststrom / pre-load current  $I_{TAV(vor)}$

Netz-Thyristor  
Phase Control Thyristor

## T 509 N 12 ...18

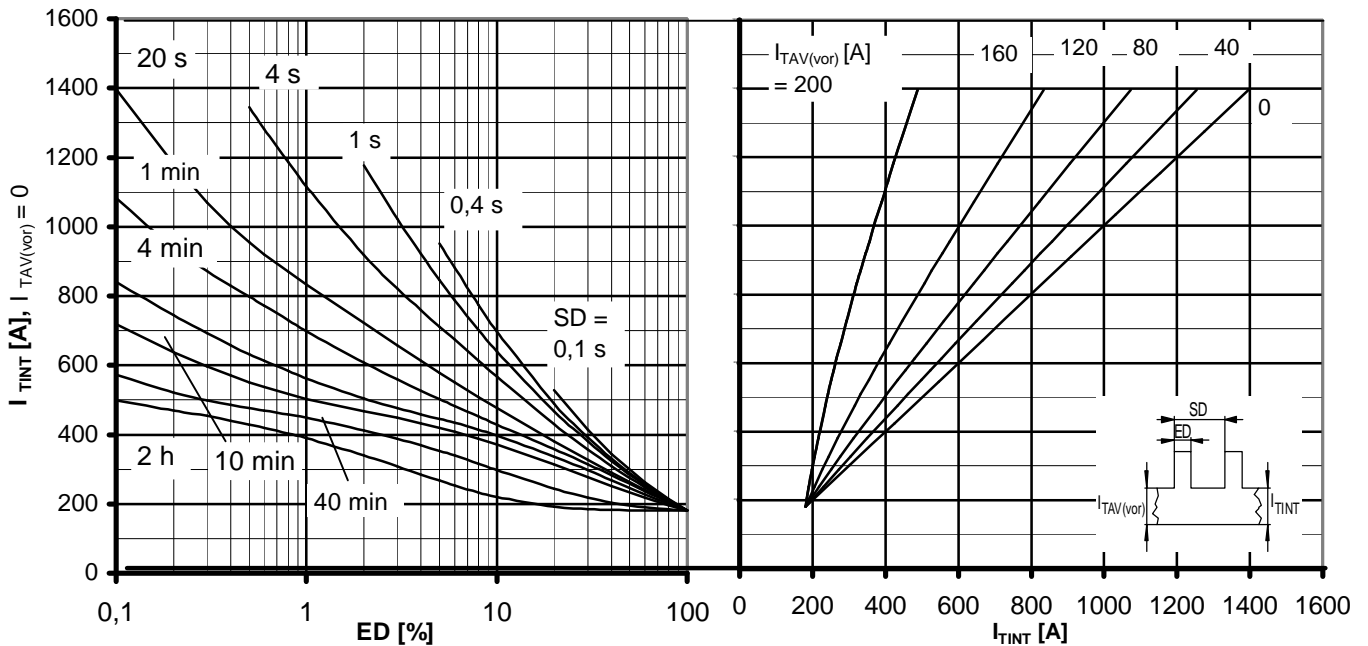

Höchstzul. Durchlaßstrom bei Ausetzbetrieb / Max. allowable on-state current during intermittent operation  $I_{TINT} = f(ED)$

Beidseitig Luftselbstkühlung / two-sided natural cooling  $K 0.05F$   
 $T_A = 45\text{ °C}$

Parameter: Vorlaststrom / pre-load current  $I_{TAV(vor)}$ , Spieldauer / cycle duration  $SD$

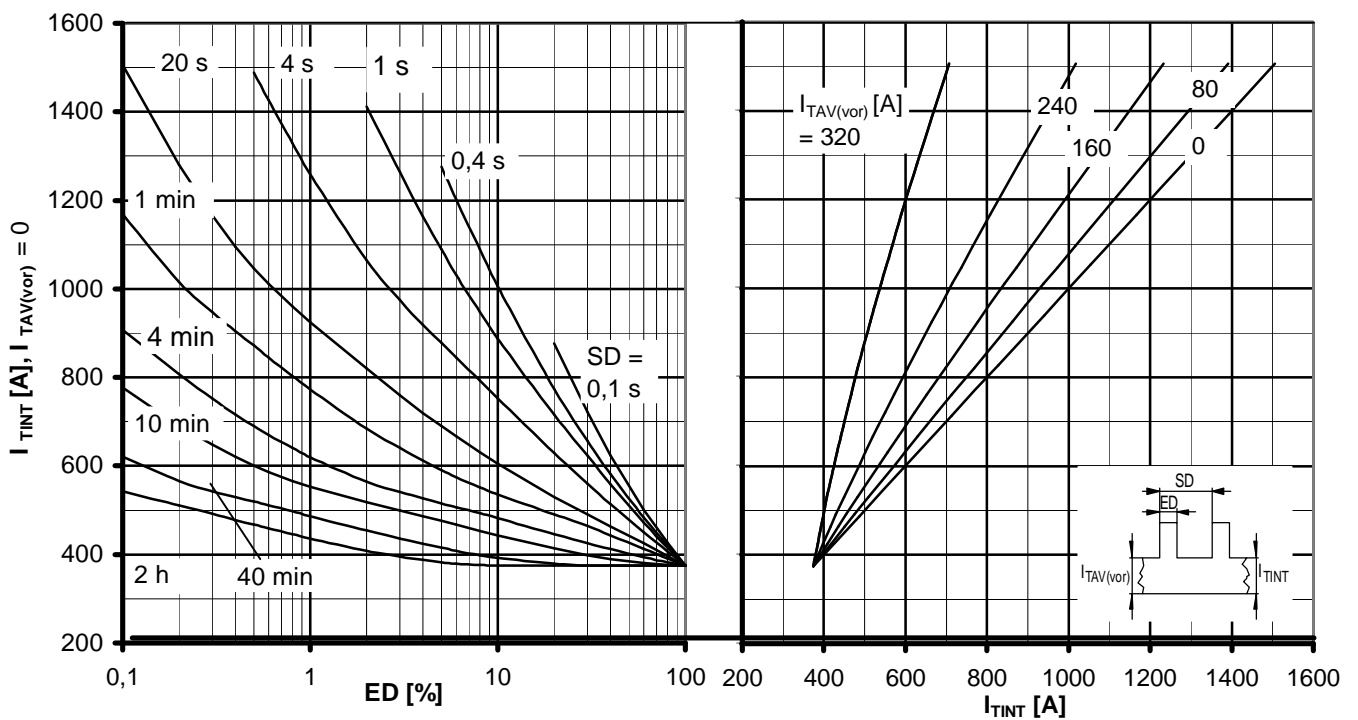

Höchstzul. Durchlaßstrom bei Ausetzbetrieb / Max. allowable on-state current during intermittent operation  $I_{TINT} = f(ED)$

Beidseitig verstärkte Kühlung / forced two-sided cooling  $K 0.05F$   
 $T_A = 35\text{ °C}$ ,  $V_L = 120\text{ l/s}$

Parameter: Vorlaststrom / pre-load current  $I_{TAV(vor)}$ , Spieldauer / cycle duration  $SD$

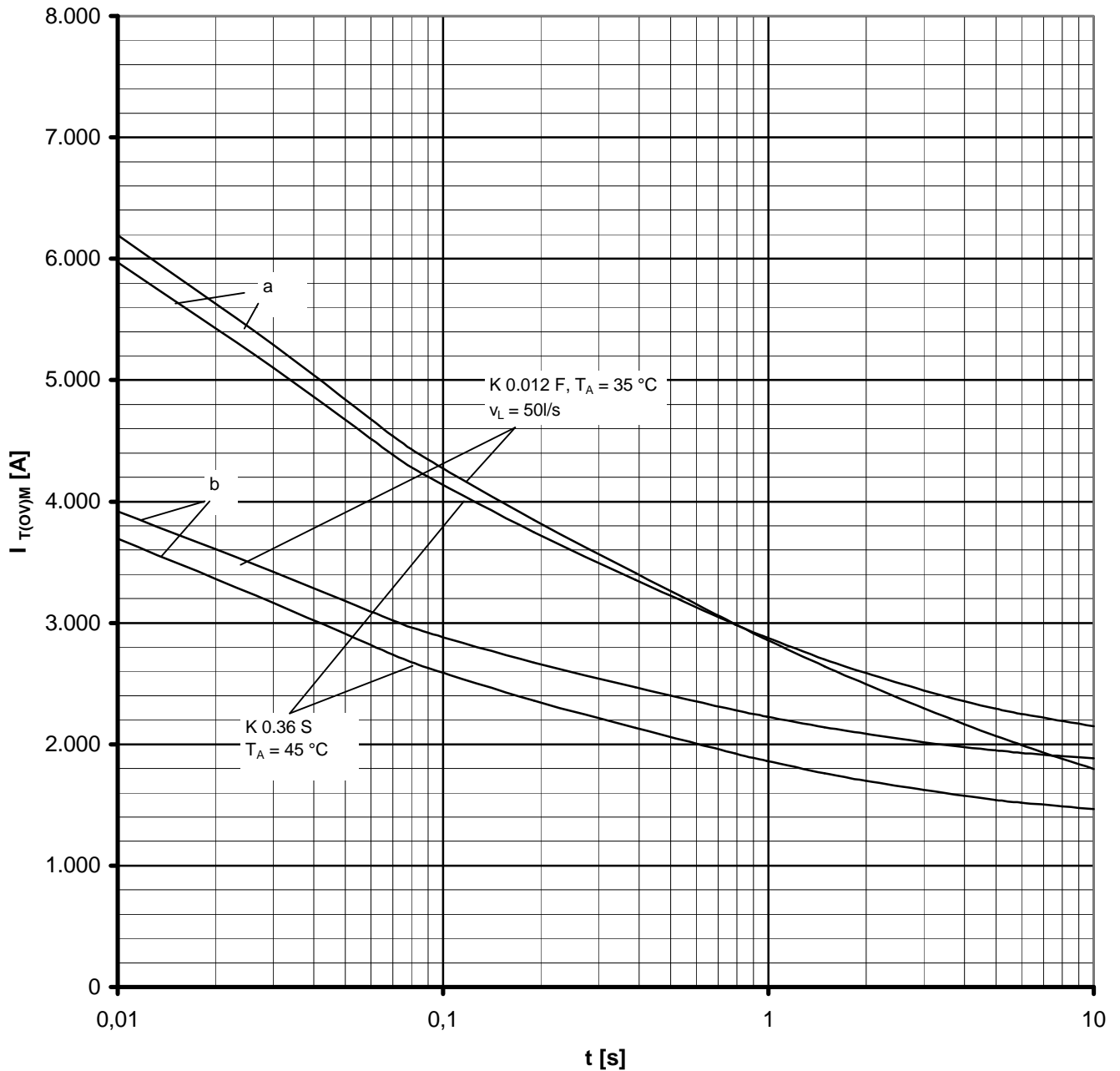

Grenzstrom / Max. overload on-state current  $I_{T(OV)M} = f(t), v_{RM} = 0,8 V_{RRM}$

Beidseitige Kühlung / Two-sided cooling

Kühlkörper / Heatsink: K0.36S, K 0.05F

Belastung aus / Surge current occurs:

a - Leerlauf / No-load conditions

b - Betrieb mit Dauergrenzstrom / During operation at max. average on-state current  $I_{TAVM}$

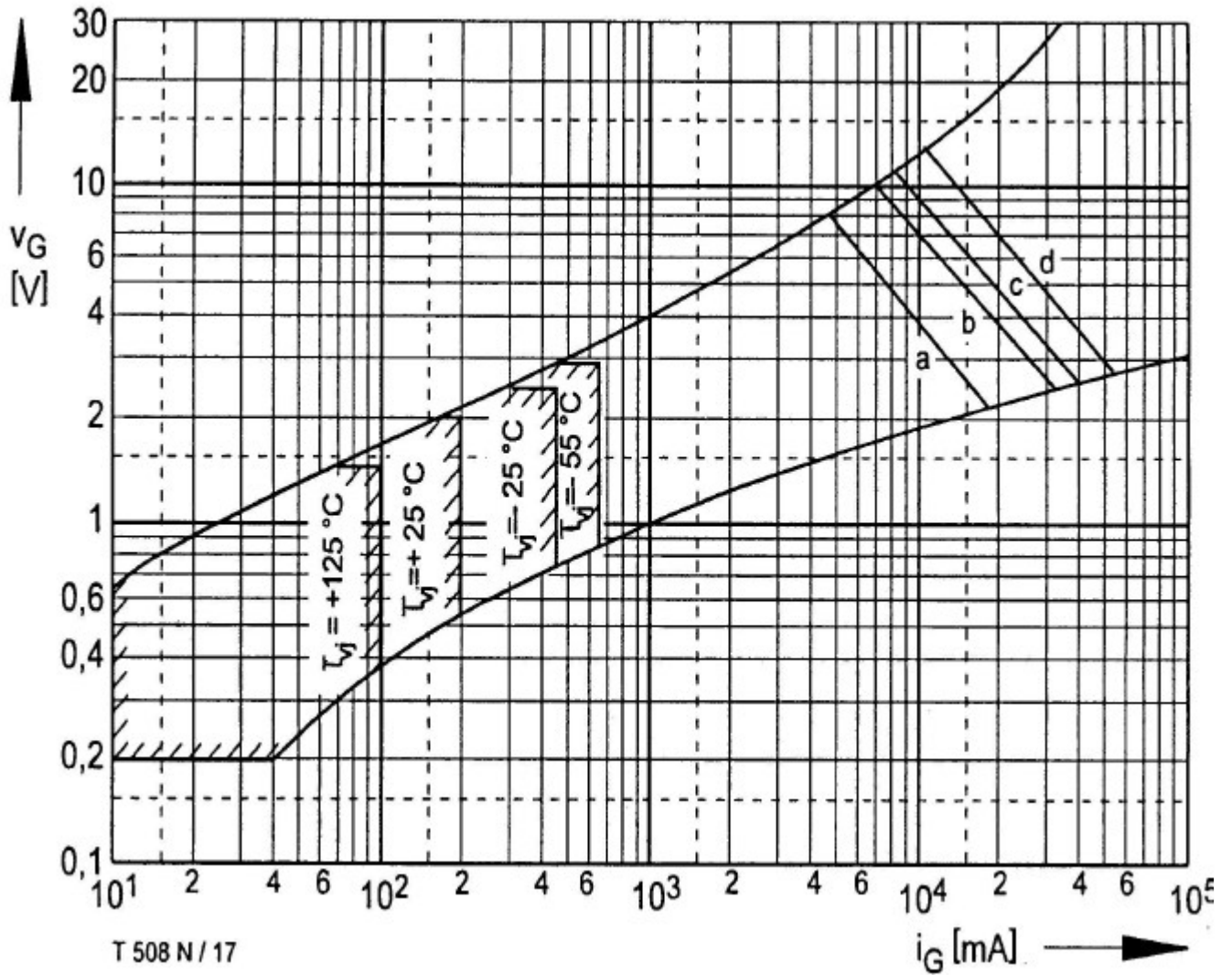

Steuercharakteristik  $v_G = f(i_G)$  mit Zündbereichen für  $V_D = 6\text{ V}$   
 Gate characteristic  $v_G = f(i_G)$  with triggering area for  $V_D = 6\text{ V}$

Höchstzulässige Spitzensteuerverlustleistung / Maximum rated peak gate power dissipation  $P_{GM} = f(t_g)$  :

a - 40 W/10ms b - 80 W/1ms c - 100 W/0,5ms d - 150 W/0,1ms

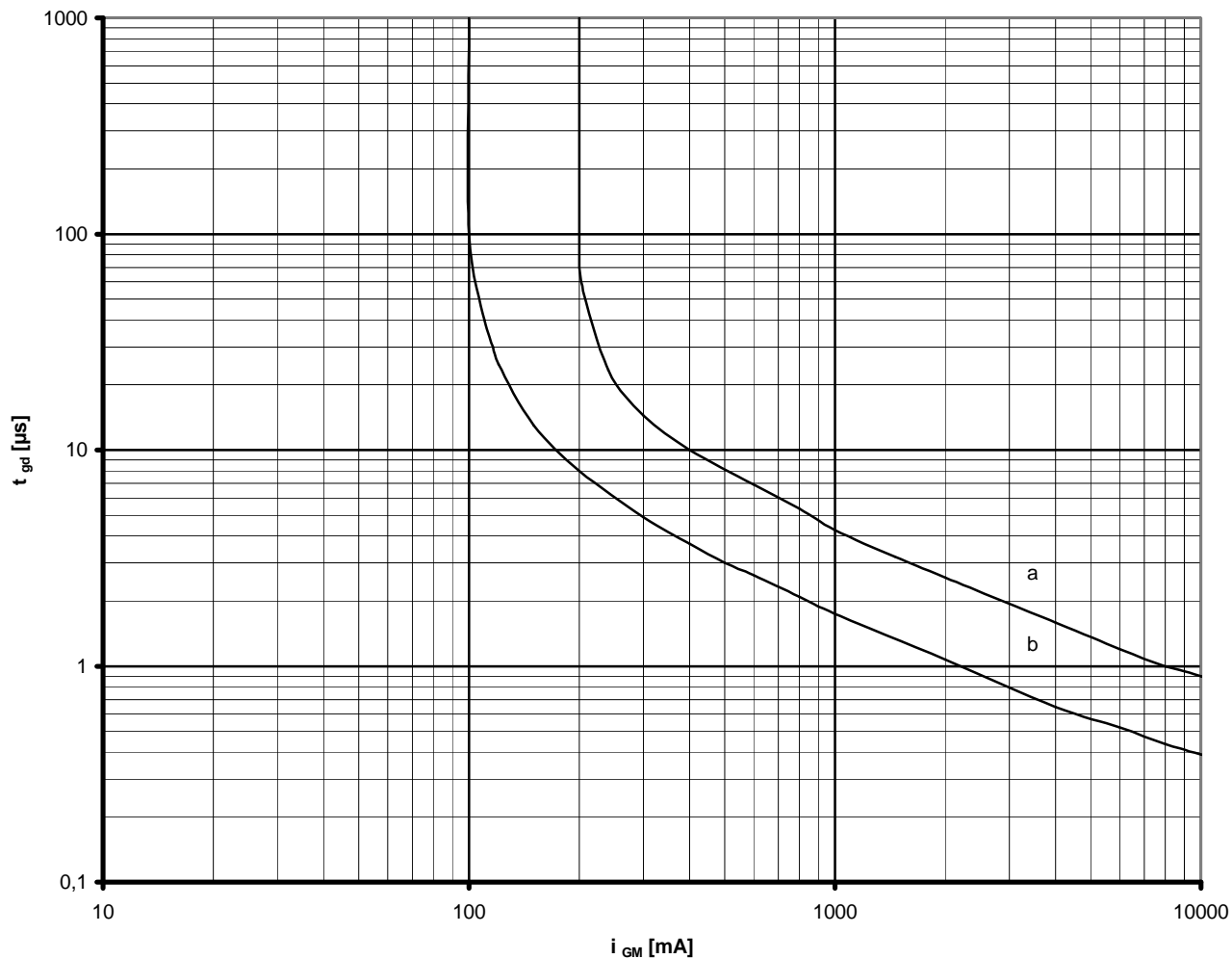

Zündverzögerung / Gate controlled delay time  $t_{gd} = f(i_{GM})$

$T_{vj} = 25^\circ\text{C}$ ,  $di_G/dt = i_{GM}/1\mu\text{s}$

a - maximaler Verlauf / limiting characteristic

b - typischer Verlauf / typical characteristic

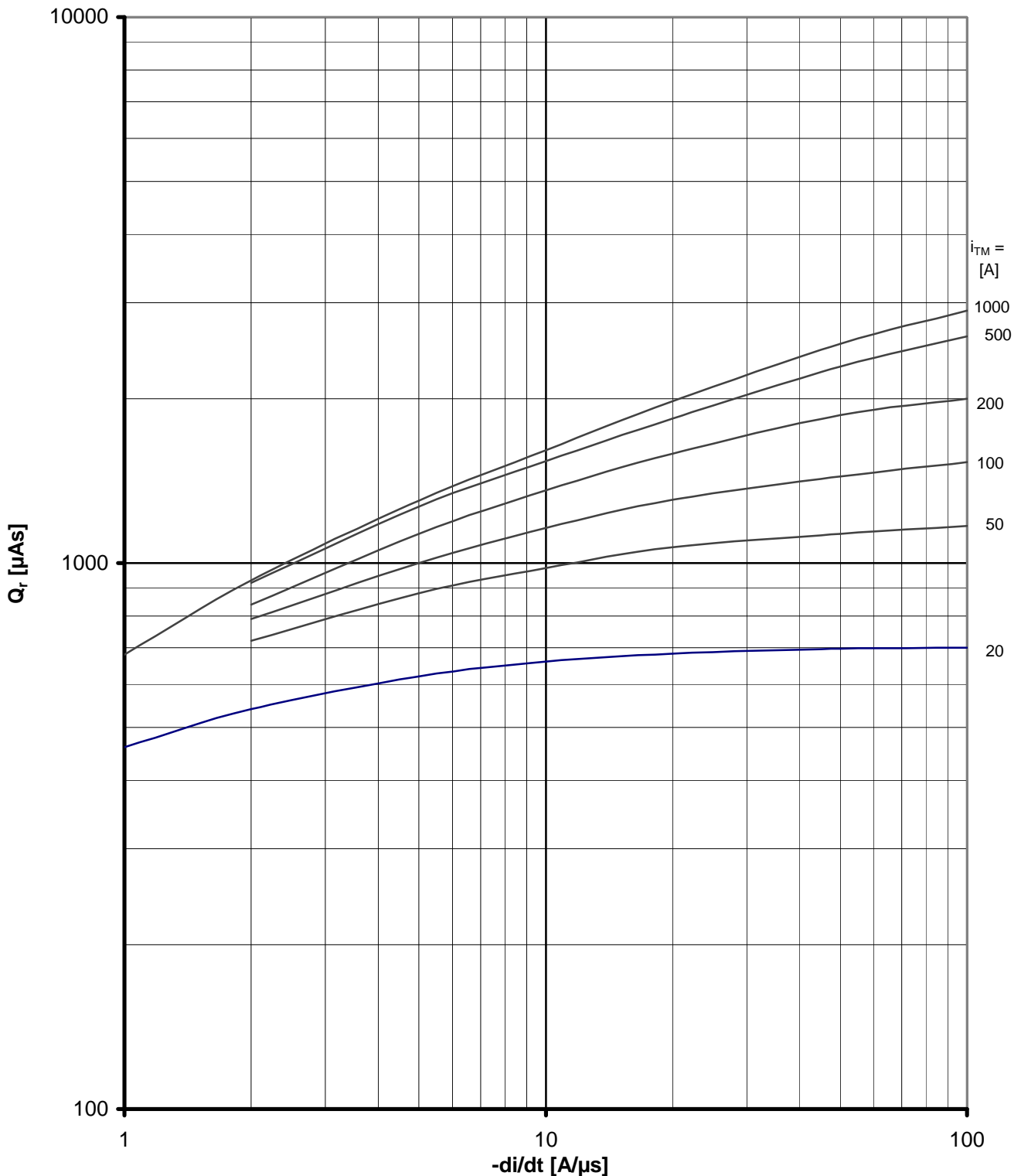

Sperrverzögerungsladung / Recovered charge  $Q_r = f(di/dt)$

$T_{vj} = T_{vj} \text{ max}$ ,  $v_R = 0,5 V_{RRM}$ ,  $v_{RM} = 0,8 V_{RRM}$

Parameter: Durchlaßstrom / On-state current  $i_{TM}$

Netz-Thyristor  
Phase Control Thyristor

T 509 N 12 ...18

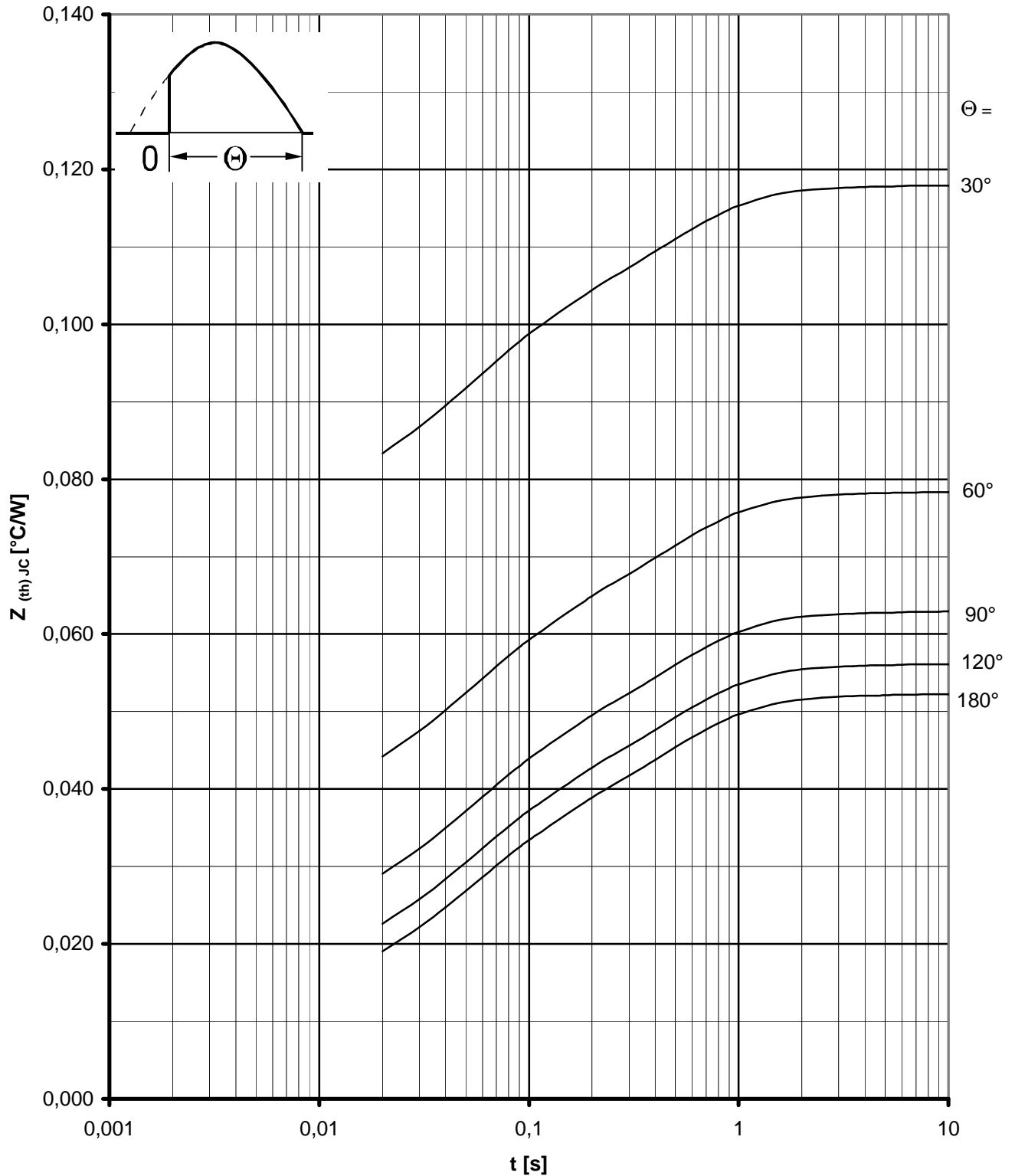
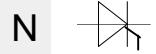

Transienter innerer Wärmewiderstand / Transient thermal impedance  $Z_{(th)JC} = f(t)$

Beidseitige Kühlung / Two-sided cooling

Parameter: Stromflußwinkel  $\Theta$  / current conduction angle  $\Theta$

Netz-Thyristor  
Phase Control Thyristor

T 509 N 12 ...18

N

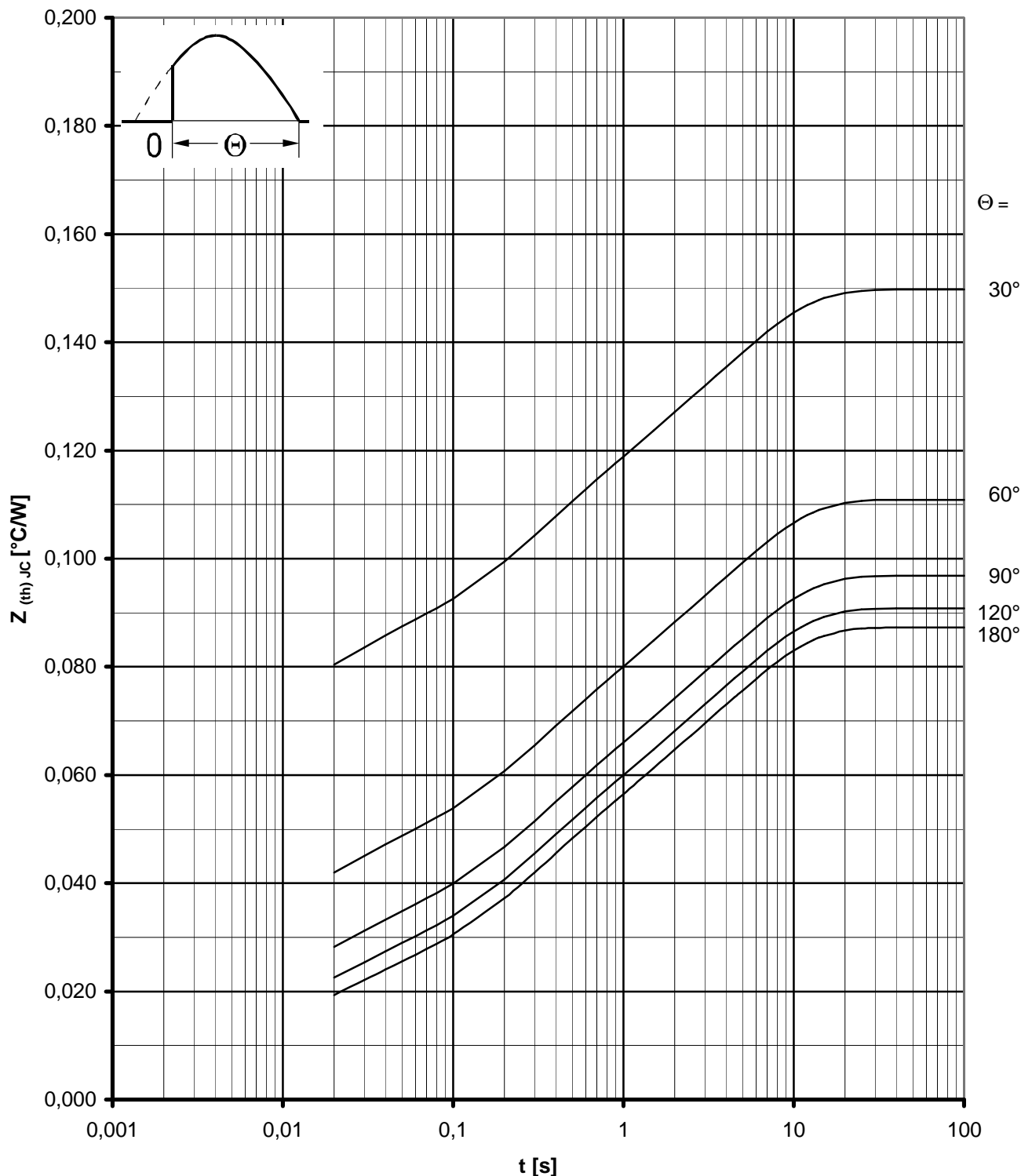

Transienter innerer Wärmewiderstand / Transient thermal impedance  $Z_{(th)JC} = f(t)$   
 Anodenseitige Kühlung / Anode-sided cooling  
 Parameter: Stromflußwinkel  $\Theta$  / current conduction angle  $\Theta$



Netz-Thyristor  
Phase Control Thyristor

T 509 N 12 ...18

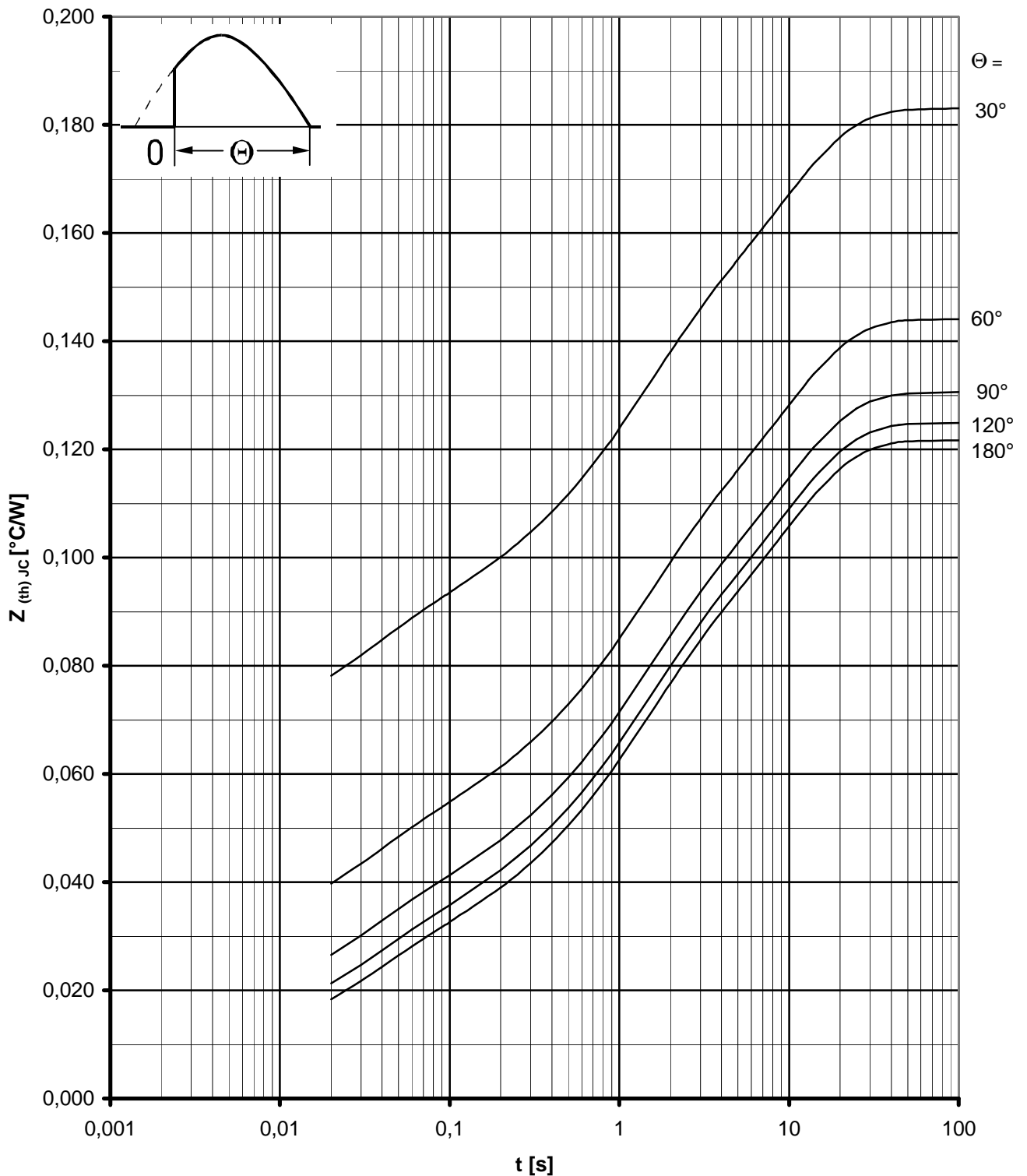
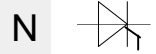

Transienter innerer Wärmewiderstand / Transient thermal impedance  $Z_{(th)JC} = f(t)$   
 Kathodenseitige Kühlung / Cathde-sided cooling  
 Parameter: Stromflußwinkel  $\Theta$  / current conduction angle  $\Theta$

Netz-Thyristor  
Phase Control Thyristor

T 509 N 12 ...18

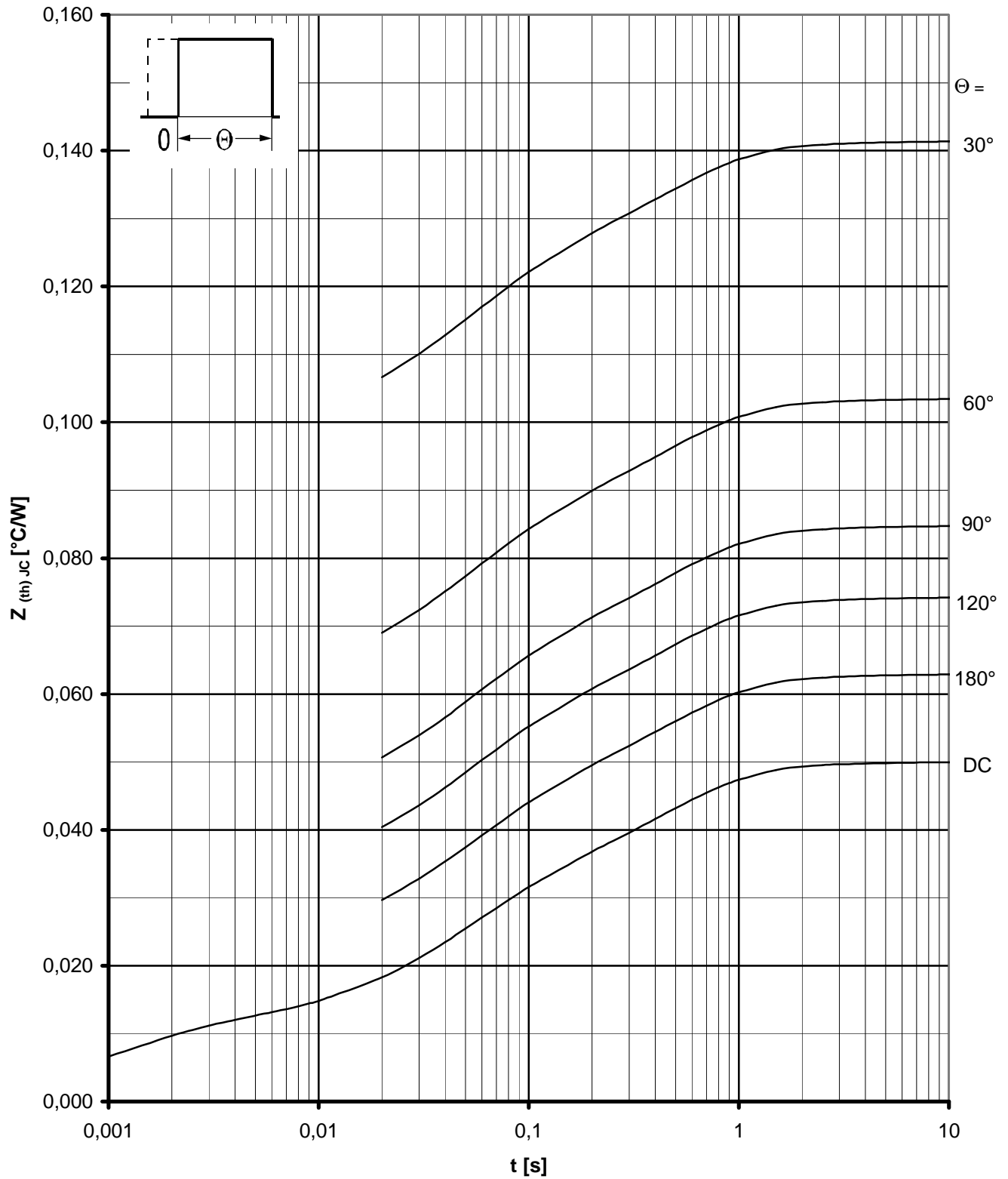
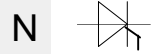

Transienter innerer Wärmewiderstand / Transient thermal impedance  $Z_{(th)JC} = f(t)$   
 Beidseitige Kühlung / Two-sided cooling  
 Parameter: Stromflußwinkel  $\Theta$  / current conduction angle  $\Theta$

Netz-Thyristor  
Phase Control Thyristor

T 509 N 12 ...18

N

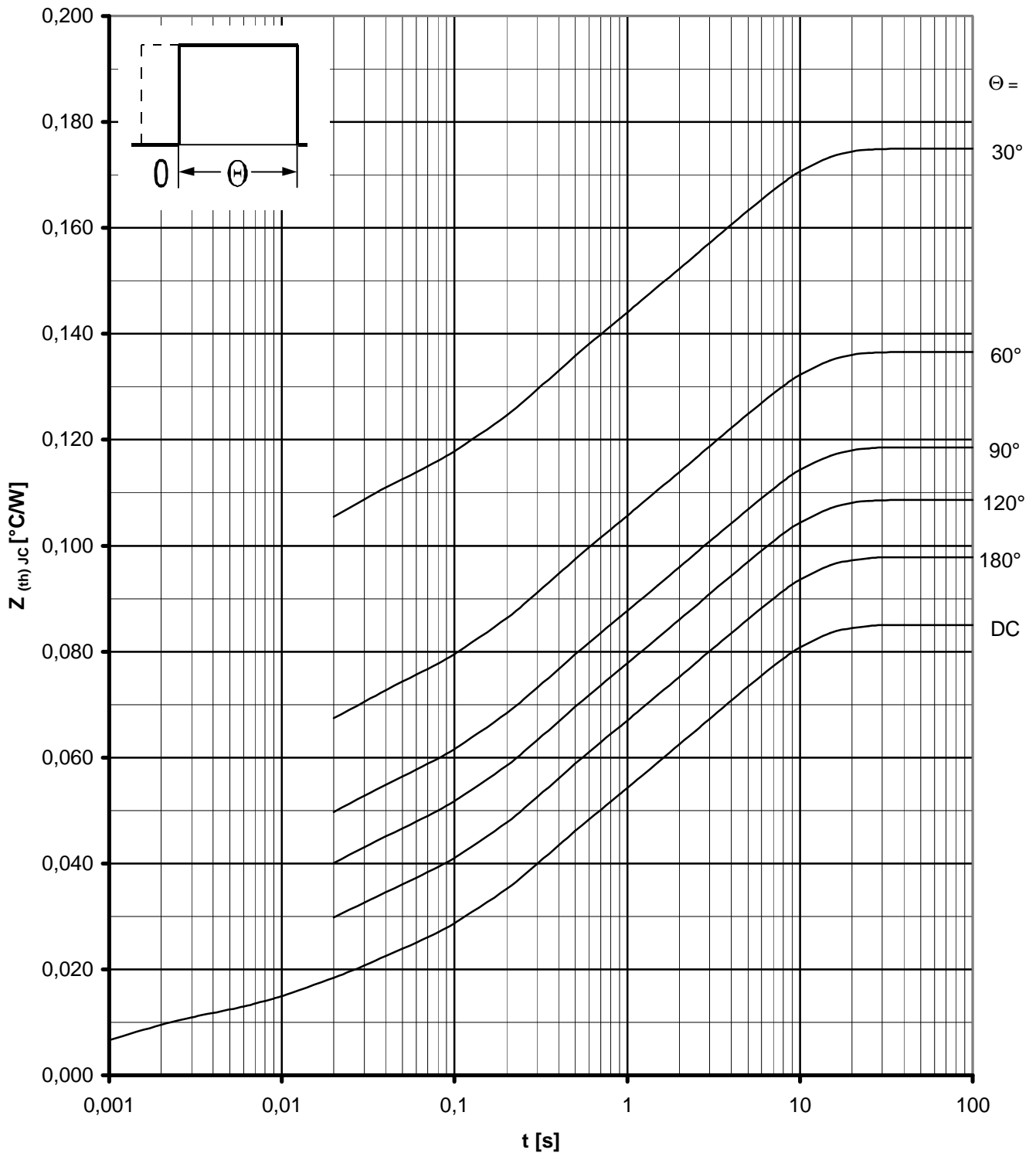

Transienter innerer Wärmewiderstand / Transient thermal impedance  $Z_{(th)JC} = f(t)$

Anodenseitige Kühlung / Anode-sided cooling

Parameter: Stromflußwinkel  $\theta$  / current conduction angle  $\theta$

Netz-Thyristor  
Phase Control Thyristor

T 509 N 12 ...18

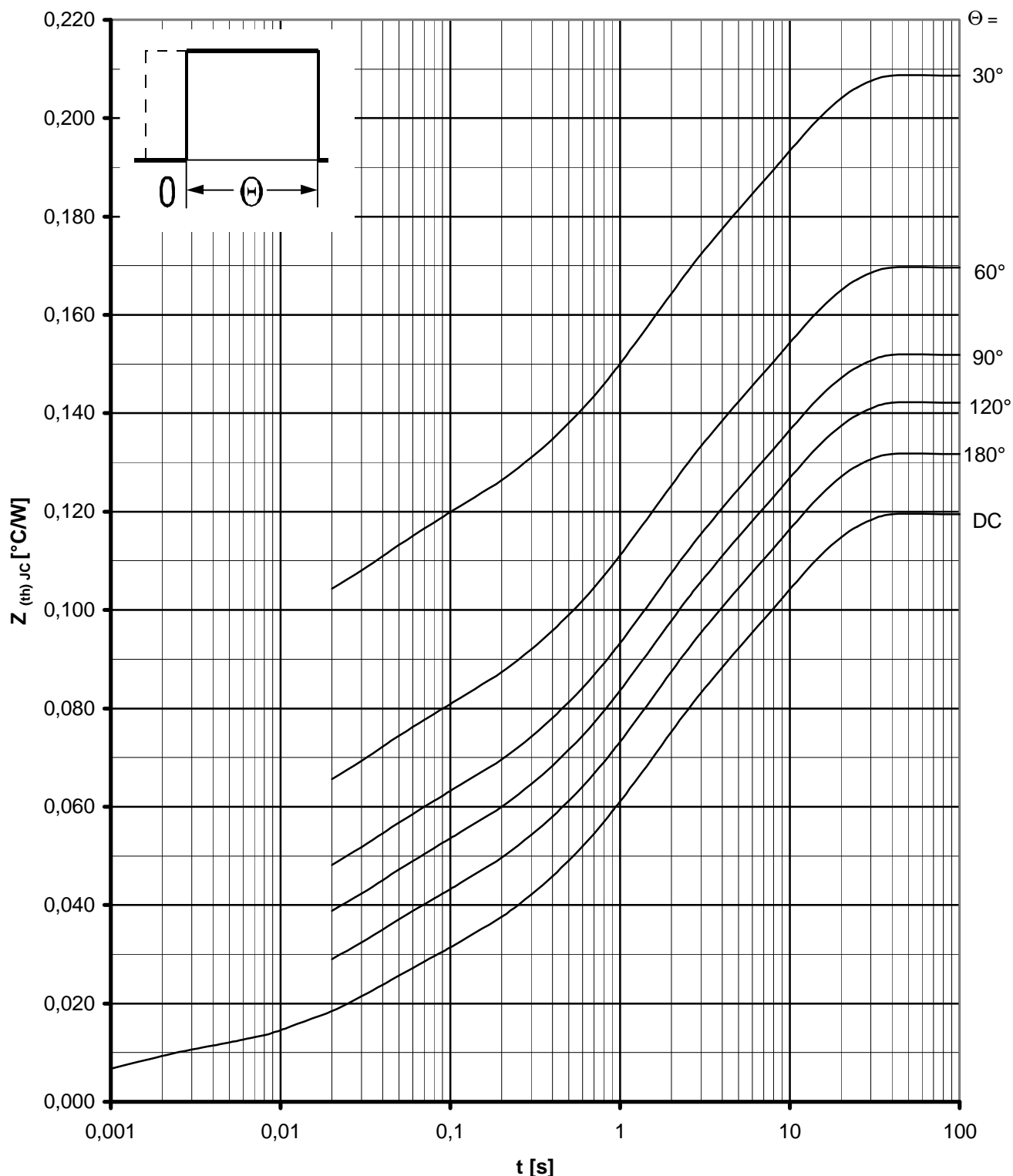

Transienter innerer Wärmewiderstand / Transient thermal impedance  $Z_{(th)JC} = f(t)$   
 Kathodenseitige Kühlung / Cathode-sided cooling  
 Parameter: Stromflußwinkel  $\Theta$  / current conduction angle  $\Theta$